

# The Economist

Vaccine trade-offs: who gets the job?

Advantage, Beijing: the West v China

Diderot's dream: Wikipedia at 20

TQ: a century of bright ideas

JANUARY 9TH-15TH 2021

# Trump's legacy

The shame and the opportunity



# DOWNLOAD

**CSS Notes, Books, MCQs, Magazines**



**THE CSS POINT**  
Yes We Can Do It!

**[WWW.THECSSPOINT.COM](http://WWW.THECSSPOINT.COM)**

- **Download CSS Notes**
- **Download CSS Books**
- **Download CSS Magazines**
- **Download CSS MCQs**
- **Download CSS Past Papers**

*The CSS Point, Pakistan's The Best  
Online FREE Web source for All CSS  
Aspirants.*

Email: [info@thecsspoint.com](mailto:info@thecsspoint.com)



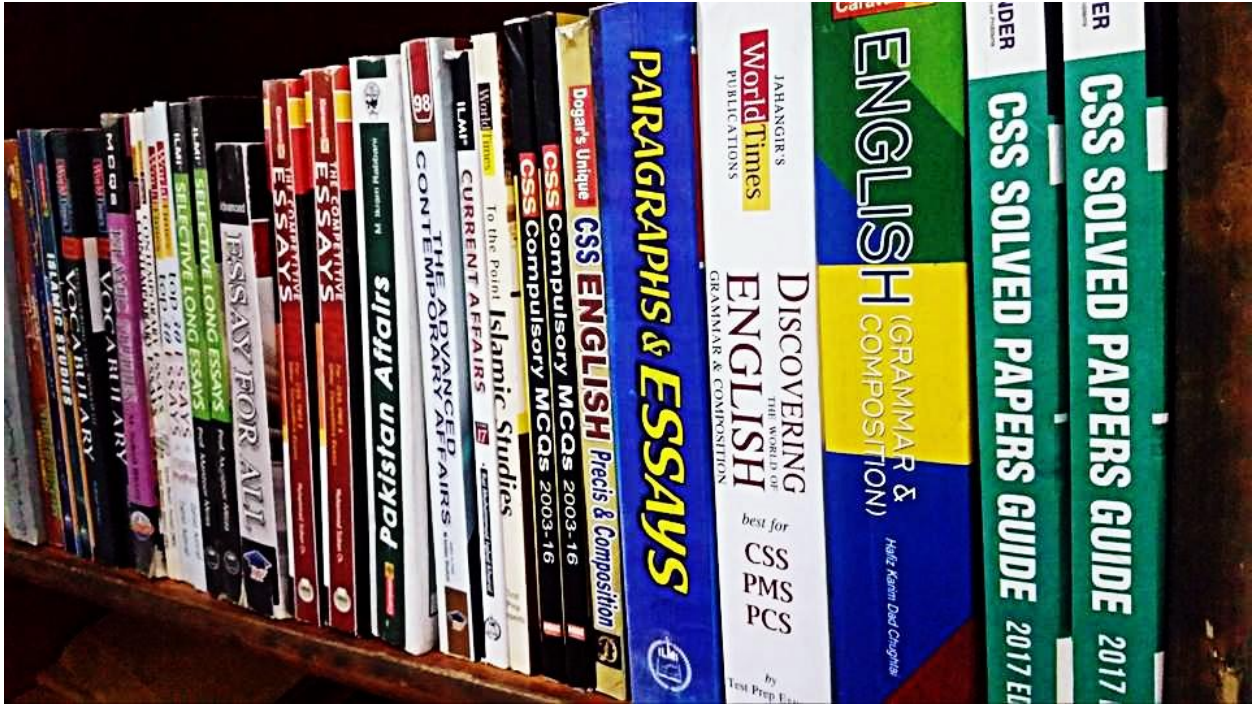

BUY CSS / PMS / NTS & GENERAL KNOWLEDGE BOOKS  
ONLINE **CASH ON DELIVERY** ALL OVER PAKISTAN

Visit Now:

[WWW.CSSBOOKS.NET](http://WWW.CSSBOOKS.NET)

For Oder & Inquiry  
Call/SMS/WhatsApp

**0333 6042057 – 0726 540141**

# PPSC Model Papers

## 79<sup>th</sup> Edition (Latest & Updated)

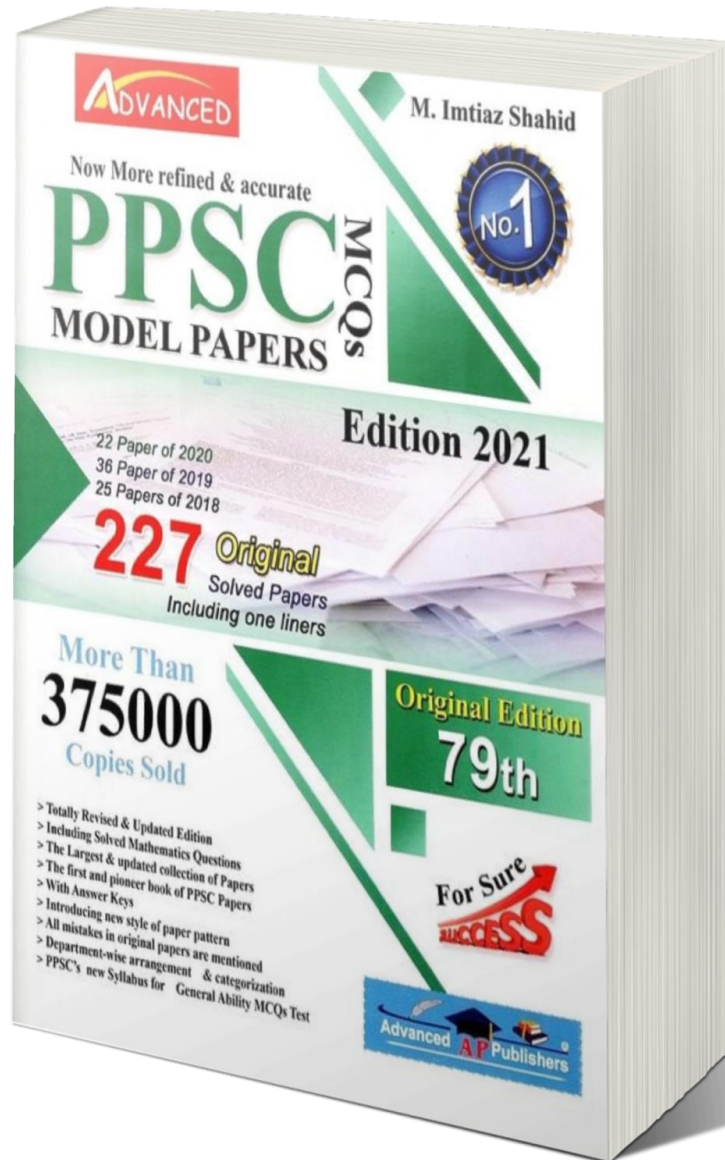

[By Imtiaz Shahid](#)

[Advanced Publishers](#)

[For Order Call/WhatsApp 03336042057 - 0726540141](#)





# ENGLISH PRECIS & COMPOSITION HAFIZ KARIM DAD CHUGTAI

CSS BOOKS.NET

Hafiz Karim  
Dad Chughtai

25%  
DISCOUNT

Cash on Delivery

GET YOUR COPY TODAY

LIMITED STOCK AVAILABLE

For Order Call/SMS  
03336042057

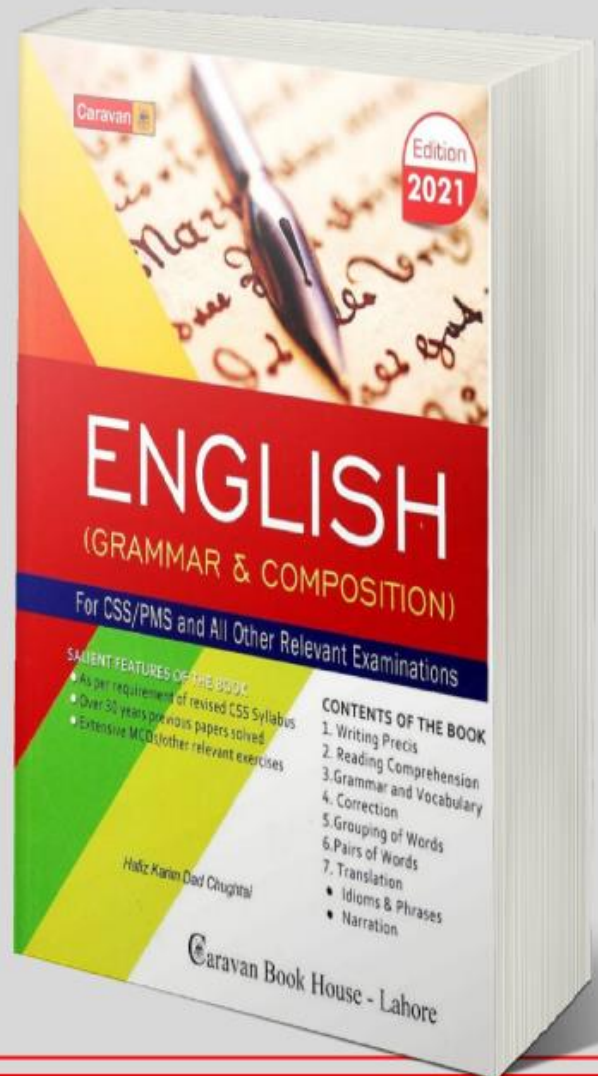

ORDER NOW

[www.cssbooks.net](http://www.cssbooks.net)

[For Order Call/WhatsApp 03336042057 - 0726540141](http://www.cssbooks.net)

# CSS SOLVED COMPULSORY MCQS

From 2000 to 2020

Latest & Updated

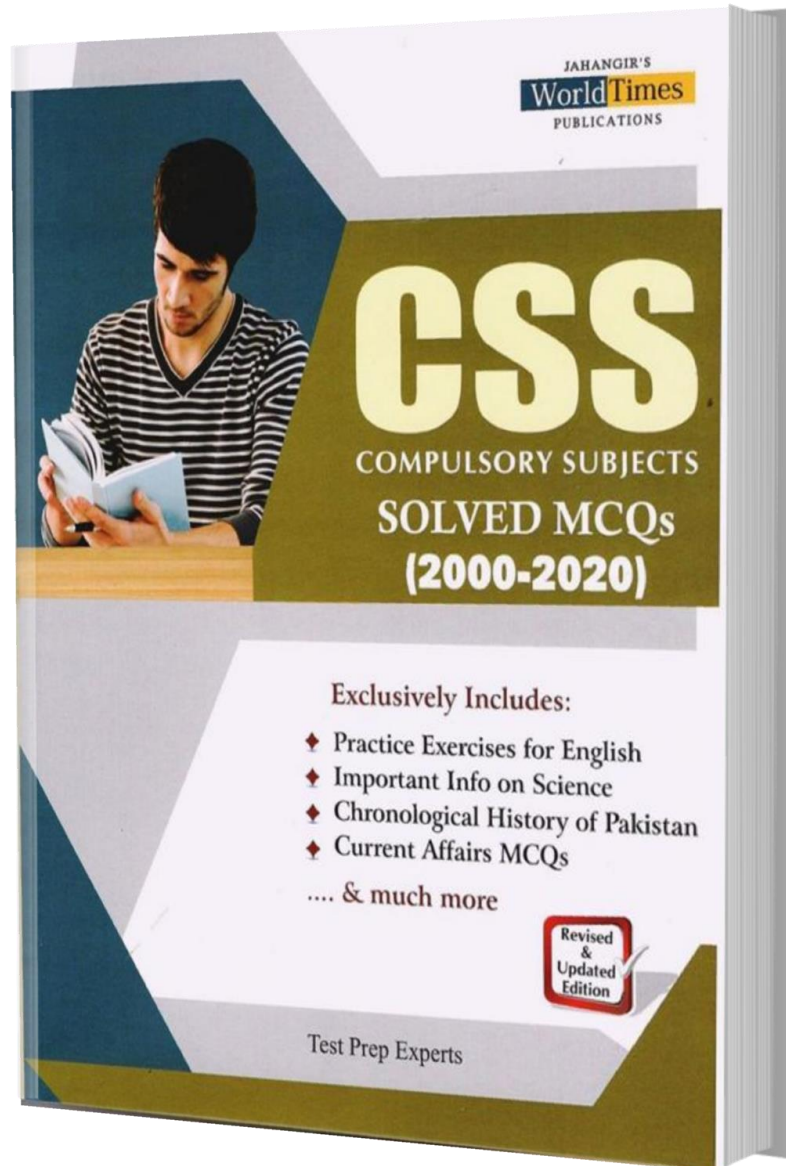

[Order Now](#)

Call/SMS 03336042057 - 0726540141

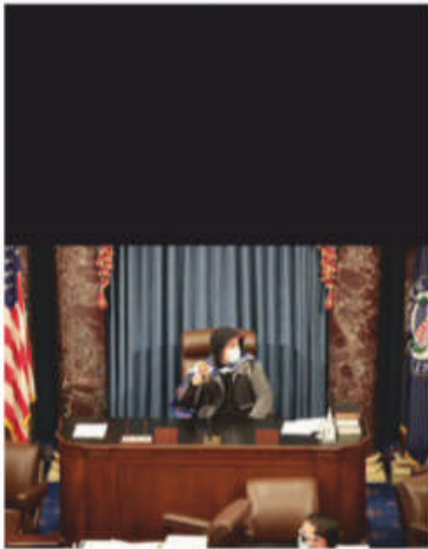

### On the cover

The invasion of the Capitol and the Republican defeat in Georgia will change American politics: leader, *page 9*. Shocking scenes in Washington, DC illustrate how Donald Trump has changed his party and how tightly he controls it, *page 22*. Two stunning victories for Democrats upend the Senate, *page 25*

- **Vaccine trade-offs** The hard task of getting jabs in arms: leader, *page 10*. The race to vaccinate the world: briefing, *page 18*

- **Advantage, Beijing** Arrests in Hong Kong and Europe's dubious trade deal show that the West is on the defensive: leader, *page 12*. The clampdown in Hong Kong, *page 34*. The flawed EU-China commercial pact: Chaguan, *page 36*

- **Diderot's dream** On its 20th anniversary, Wikipedia's reputation has never been higher: leader, *page 11* and analysis, *page 51*. The online encyclopedia is still growing rapidly in Asia and Africa: graphic detail, *page 77*

→ We are working hard to ensure that there is no disruption to print copies of The Economist as a result of the coronavirus. But if you have digital access as part of your subscription, then activating it will ensure that you can always read the digital version of the newspaper as well as all of our daily journalism. To do so, visit [economist.com/activate](http://economist.com/activate)

### The world this week

6 A summary of political and business news

### Leaders

9 **Trump's legacy**  
Shame and opportunity

10 **Vaccines**  
Who gets the jab?

11 **Cryptocurrencies**  
If you can't beat them

11 **Encyclopedias**  
Diderot's dream

12 **Dealing with China**  
Advantage, Beijing

14 **Democracy in Africa**  
Time out

### Letters

17 On military deception, Singapore, Christian Democrats, Cuba, accents, banking

### Briefing

18 **Vaccinating the world**  
The great task

**Technology Quarterly**  
**The liberation of light**  
*After page 40*



**Banyan** Is North Korea's dictator losing his touch?  
*Page 32*



### United States

22 The Republican Party: after the insurrection

25 Georgia's run-off elections

26 American policy and the Uyghurs



### The Americas

28 Abortion rights

29 Barbados's covid-19 spike



### Asia

30 India's private schools

31 Elections in Kazakhstan

32 **Banyan** Speechless in North Korea

33 Muslims in Japan



### China

34 Arrests in Hong Kong

35 Female comedians

36 **Chaguan** The EU's cynical handling of China



### Middle East & Africa

37 Bourgeois blues in Africa

38 Globalising baboons

39 Basketball in South Sudan

39 Tension in the Gulf

40 Syrian refugees stay put





**Europe**

- 41 Transatlantic relations
- 42 Spain's government
- 43 Gibraltar, Britain and Spain
- 44 Laptop learning in Greece
- 44 The Dutch monarchy
- 45 **Charlemagne** The clown ceiling

**Britain**

- 47 Racing the virus
- 48 Digital privacy
- 49 Remaining Europeans
- 50 **Bagehot** Victory goes to the patient

**International**

- 51 Wikipedia at 20

**Business**

- 53 Deutschland AG in China
- 54 America v China Inc
- 55 A Stellantis is born
- 55 An M&A revival
- 56 Big oil and the Arctic
- 56 Corporate charity
- 57 **Bartleby** The science of networking
- 58 **Schumpeter** A tech CEO's guide to taxes

**Finance & economics**

- 61 The markets' march
- 62 **Buttonwood** Equity valuations
- 63 Bitcoin zooms
- 64 Divining water risk
- 64 Delistings in China
- 65 The pandemic's price tag
- 66 **Free exchange** Rethinking welfare

**Science & technology**

- 67 Warfare's worldwide web
- 69 The domestication of dogs
- 69 Better ocean cartography
- 70 Herbal medicine's uses

**Books & arts**

- 71 Authenticating art
- 72 The Cultural Revolution
- 73 Arctic explorers
- 74 Revisiting the Troubles
- 74 Fictional trauma

**Economic & financial indicators**

- 76 Statistics on 42 economies

**Graphic detail**

- 77 Wikipedia's rise in developing countries

**Obituary**

- 78 Agitu Gudeta, a refugee who made cheese and touched hearts

The Economist

Volume 438 Number 9227

Published since September 1843 to take part in "a severe contest between intelligence, which presses forward, and an unworthy, timid ignorance obstructing our progress."

**Editorial offices in London and also:** Amsterdam, Beijing, Berlin, Brussels, Chicago, Dakar, Dallas, Dubai, Johannesburg, Madrid, Mexico City, Moscow, Mumbai, New Delhi, New York, Paris, San Francisco, São Paulo, Seoul, Shanghai, Singapore, Tokyo, Washington DC

**Subscription service**

For our full range of subscription offers, including digital only or print and digital bundled, visit: [Economist.com/offers](http://Economist.com/offers)

If you are experiencing problems when trying to subscribe, please visit our Help pages at: [www.economist.com/help](http://www.economist.com/help) for troubleshooting advice.

The best way to contact our Customer Service team is via phone or live chat. You can contact us on the below numbers; please check our website for up to date opening hours.

North America: +1 800 456 6086  
Latin America & Mexico: +1 636 449 5702

Please recycle



**PEFC certified**  
This copy of *The Economist* is printed on paper sourced from sustainably managed forests certified to PEFC [www.pefc.org](http://www.pefc.org)

We know our children's future is being rewritten. What will change in years to come? We cannot say, nor can we be sure that traditional ideas will do for today and do for tomorrow. Is sustainable investing the solution for them?



**For some of life's questions, you're not alone.  
Together we can find an answer.**

[ubs.com/lifegoals](https://ubs.com/lifegoals)

Sustainable investing strategies aim to incorporate environmental, social and governance (ESG) considerations into investment process and portfolio construction. Strategies across geographies and styles approach ESG analysis and incorporate the findings in a variety of ways. The returns on portfolios consisting primarily of sustainable investments may be lower or higher than portfolios where ESG factors, exclusions, or other sustainability issues are not considered, and the investment opportunities available to such portfolios may also differ. As a firm providing wealth management services to clients, UBS Financial Services Inc. offers investment advisory services in its capacity as an SEC-registered investment adviser and brokerage services in its capacity as an SEC-registered broker-dealer. Investment advisory services and brokerage services are separate and distinct, differ in material ways and are governed by different laws and separate arrangements. It is important that clients understand the ways in which we conduct business, that they carefully read the agreements and disclosures that we provide to them about the products or services we offer. For more information, please review the PDF document at [ubs.com/relationshipsummary](https://ubs.com/relationshipsummary). © UBS 2021. All rights reserved. UBS Financial Services Inc. is a subsidiary of UBS AG. Member FINRA/SIPC.





Despite the storming of the Capitol building by a mob of supporters of Donald Trump, more than 100 Republican congressmen and a handful of senators persisted in their challenge to the certification of **Joe Biden's victory** in America's presidential election. The protesters were egged on by Mr Trump. Rather than condemn the violence he said they were "very special". Mr Biden's win was eventually confirmed by Congress. Earlier, ten former secretaries of defence, including Dick Cheney and Donald Rumsfeld, felt it necessary to write an open letter reminding the armed forces of their "solemn obligations" to support the constitution.

Democrats won both run-off elections in **Georgia** for Senate seats, giving the party control of the chamber. Raphael Warnock was one of the victors. He is the first black person from the South to hold a Senate seat since the post-civil-war era, and only the 11th black senator overall.

A judge in Britain refused America's extradition request for **Julian Assange**, finding that the founder of WikiLeaks is at risk of committing suicide. America's Justice Department will appeal against the ruling, noting that the court had accepted all the legal points it had raised about Mr Assange's leaking of classified material. Mexico has offered him political asylum.

**Britain** was once again in lockdown, as cases and deaths from covid-19 soared. Schools were shut down, a day after Boris Johnson, the prime minister, insisted they were safe. Mr Johnson also cancelled

school academic exams this summer, but forgot about the vocational exams taking place this month. The minister in charge left the decision on whether to hold these assessments in subjects such as health and social care to the institutions themselves, creating more confusion.

There was increasing concern within the **European Union** that vaccination programmes have got off to a slow start. Although Britain has injected around 1.5% of its population already, Germany has administered merely 317,000 jabs, or 0.4% of its people. France did not break the 1,000 mark until January 4th. The Netherlands did not start vaccinations until January 6th. Many blame the European Commission's centralised procurement system for vaccines, though national delivery systems are plainly also at fault.

With little fuss, Britain and the EU began their post-Brexit **trading** arrangements.

A new National Assembly dominated by the Socialist party loyal to the dictatorial regime of Nicolás Maduro took office in **Venezuela**. It replaces a legislature controlled by the opposition, which lost an election in December that was widely regarded as fraudulent. Juan Guaidó, the speaker of the outgoing assembly, who was recognised by more than 50 democracies as Venezuela's interim president, held a swearing-in ceremony for a parallel legislature.

Saudi Arabia, the United Arab Emirates, Bahrain and Egypt restored diplomatic relations with **Qatar**, a step towards ending a three-and-a-half-year dispute. The four countries imposed an embargo on Qatar over its ties to Iran and Islamists, and the content of its Al Jazeera media network. Saudi Arabia has already reopened its borders with the emirate.

**Iran** said it would begin enriching uranium to 20% purity, short of the 90% required to

make a nuclear bomb, but in breach of the deal it signed with world powers in 2015. It also raised tensions by seizing a South Korean tanker for "polluting the Persian Gulf".

Around 100 people were killed by suspected jihadists in attacks on two villages in western **Niger**. In **Mozambique** Total, a French energy firm, suspended construction work on Africa's largest natural-gas project because of attacks by jihadists allied to Islamic State in the north of the country.

Faustin-Archange Touadéra, the president of the **Central African Republic**, won a second term in elections marred by an offensive led by rebel groups who accuse the government of rigging the vote.

Police in **Hong Kong** arrested more than 50 pro-democracy activists and politicians for alleged violations of a national-security law imposed last year. They were accused of subversion for organising an unofficial primary election to select candidates for the Legislative Council. They wanted to overthrow the government, said a senior official.

**China** stopped a team of investigators from the World Health Organisation from entering the country, citing visa problems. China said it would hurry the approval of their documents, but its obstruction does not bode well for the WHO's investigation into the origins of covid-19.

**Vietnam** sentenced three journalists to prison terms of more than ten years each for disseminating anti-state propaganda. One of them was arrested after calling on the EU to postpone a trade agreement until Vietnam improved its treatment of journalists.

Kim Jong Un, **North Korea's** dictator, admitted that his regime had completely failed to meet its economic goals in a rare congress of the ruling Workers' Party. He pledged to do better this year.

## Coronavirus briefs

To 6am GMT January 7th 2021

### Weekly confirmed cases by area, m

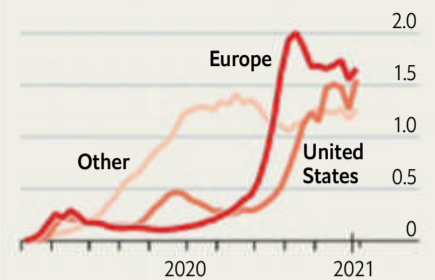

### Confirmed deaths\*, selected countries

	Per 100k	Total	This week
Belgium	171.6	19,883	442
Italy	127.1	76,877	3,273
Czech Rep.	116.1	12,436	1,007
Peru	115.0	37,925	351
Britain	113.9	77,346	4,798
Spain	110.0	51,430	741
United States	108.6	359,406	18,716
Hungary	105.6	10,198	769
France	101.4	66,197	2,181
Mexico	100.8	129,987	5,090

Sources: Johns Hopkins University CSSE; UN; The Economist \*Definitions differ by country

Indonesia, Japan and South Korea were among the **Asian** countries imposing new restrictions in an effort to battle a surge in covid-19 infections in the region. Vaccinations in Japan are not expected to begin until the end of February.

**India's** drug regulator approved the AstraZeneca-Oxford vaccine. It also cleared Covaxin, a vaccine developed by an Indian company that is still in the clinical-trial stage.

A national lockdown in **Germany** was extended by three weeks, to January 31st. Strict curbs on travel were imposed in areas with the highest infection rates.

**Israel** continued to lead the world in vaccination per person, inoculating 16% of its people by January 5th. **Russia** said it had vaccinated 1m people with the Sputnik V jab. Many Russians are refusing it; Vladimir Putin says he will have the jab, at some point.

→ For our latest coverage of the virus please visit [economist.com/coronavirus](https://www.economist.com/coronavirus) or download the Economist app.



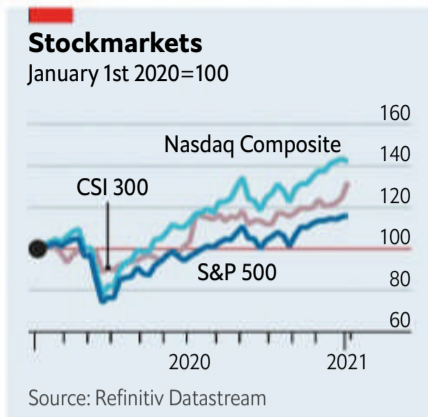

American **stockmarkets** swiftly recovered from their drubbing on the first trading day of the year, their worst decline since October. Share indices had fallen amid the news about rapidly spreading virulent strains of covid-19, but investors soon shrugged off those concerns. The S&P 500 gained 16% over the whole of last year, and the NASDAQ—bouyed by tech firms—44%. (The big losers were energy shares, which dropped by almost 40% in 2020.) China's stockmarkets are also on a roll. The CSI 300 index of shares listed in Shanghai and Shenzhen closed this week at its highest point since the global financial crisis in 2008.

The share prices of Alibaba and Tencent fell amid reports that the Trump administration is considering delisting the Chinese digital stars from American stockmarkets. Donald Trump has issued an executive order forbidding American investors from holding shares in companies with suspected links to the Chinese armed forces. Earlier the **New York Stock Exchange** got itself in a muddle about delisting three Chinese telecom companies, reversing its decision to remove them. It eventually said it would strike the three from the market, after receiving a stern lecture from the Treasury.

In the twilight of his presidency, Mr Trump signed an order banning **Chinese payment apps**, including Alipay, from operating in America because of alleged security risks. The justification was based in part on the Indian government's ban of 200 Chinese apps, even though that proscription is

widely seen as being driven by India's retaliation against China in a diplomatic spat.

Britain's Competition and Markets Authority asked interested third parties for their comments on **Nvidia's** \$40bn takeover of **Arm**, a chip designer based in Cambridge. The CMA is now responsible for complex antitrust cases involving British firms following the end of Britain's transition period to leave the EU.

### Back to black

Saudi Arabia said it would cut its **oil output** by an extra 1m barrels a day in February and March, a decision it took unilaterally to counteract Russia's smaller increase in production. The Saudi's surprise announcement came after the latest meeting between OPEC and Russia had agreed to keep output steady. Oil prices soared, pushing Brent crude to above \$54 a barrel for the first time since March.

The World Bank estimated that the **world economy** will grow by 4% in 2021. It thinks China's GDP will expand by 7.9% and America's and the euro area's by around 3.5%. The good news was tempered by the fact that by 2022, global GDP is still

expected to be 4.4% below pre-pandemic projections. The report stressed that covid-19 vaccination programmes, including in poorer countries, are essential for the health of the global economy.

Announced three years ago to much fanfare about being a transformative moment for the **health-care industry**, Amazon, JPMorgan Chase and Berkshire Hathaway quietly shelved Haven, a joint venture they set up to lower staff health-care costs. Haven promised to pool technological solutions to provide cheaper insurance, but each company will now work on its own in-house projects instead.

**Fiat Chrysler Automobiles** and Groupe PSA, the owner of **Peugeot**, sealed their merger, more than a year after it was announced. The new company is called Stellantis and will list its shares in Milan, Paris and New York. Like its rivals, Fiat Chrysler recorded an acceleration of sales in America in the final months of 2020, which will be a bright spot in the forthcoming dismal annual earnings from carmakers.

**Tesla** also delivered more cars than had been expected towards the end of the year. It

fell just shy of its half-million target for all of 2020, which is still up by a third on 2019.

**British Airways** obtained a £2bn (\$2.7bn) loan underwritten by banks and backed by the British government's export credit agency. Until it pays back the loan BA will not be allowed to pay dividends to International Airlines Group, its parent company.

Just when passengers need them most, **emotional-support animals** are to be banned on American Airlines, the first big carrier to follow a ruling that says the animals can be treated as pets and barred from the cabin (dogs for disabled people are an exception). Airlines are contending with a rising number of requests from customers to travel with their animals, which have included pigs, turtles, squirrels and peacocks. One former Google employee took her bunny in business class to Tokyo.

### Rust never sleeps

**Neil Young** became the latest rock superstar to make a mint from selling the rights to his songs. Hipgnosis, a music-investment company, paid a reported \$150m for a 50% stake in the Young catalogue.

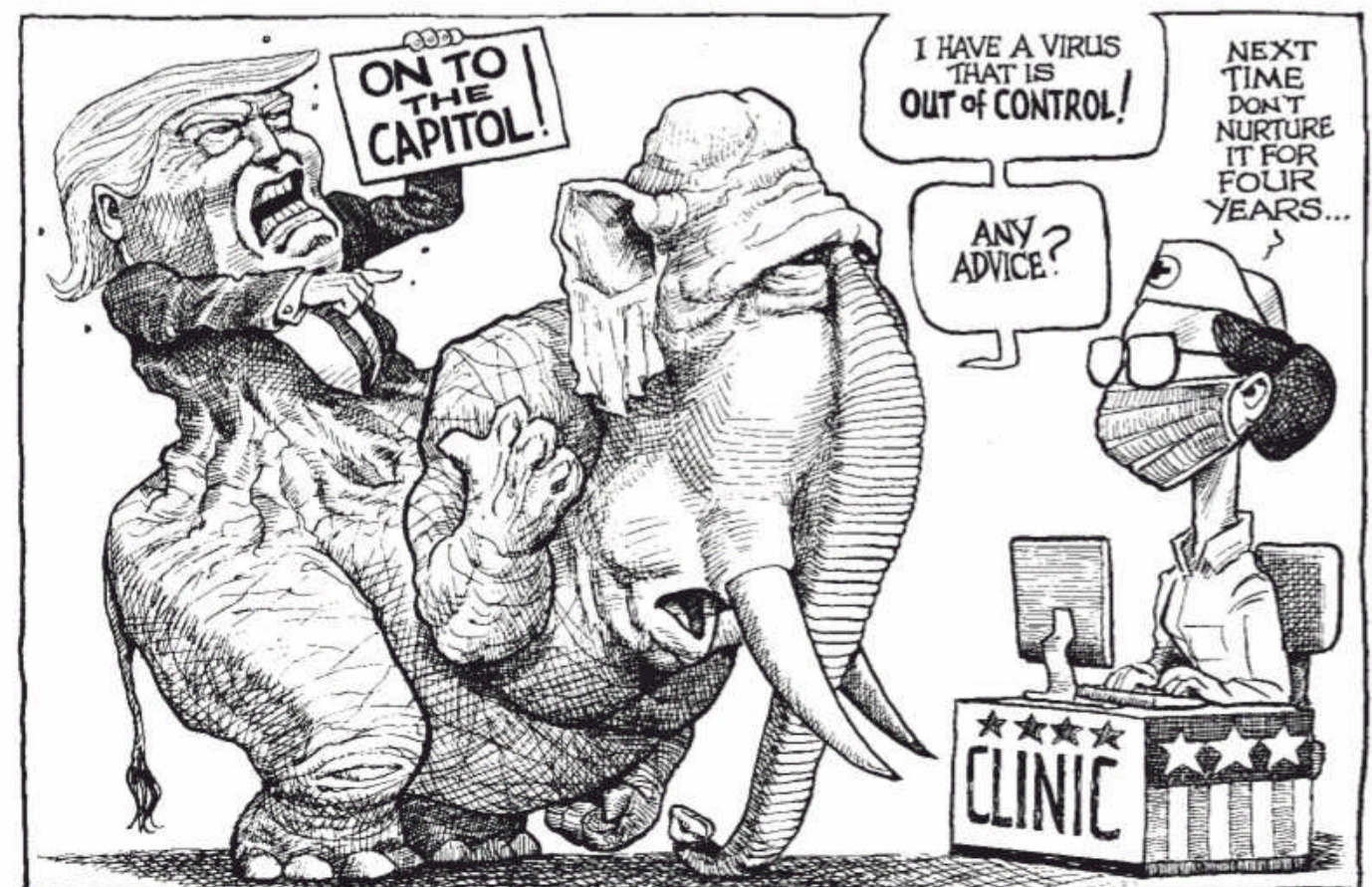



ALL IN ON BEATS



ALL IN ON STREETS



THE NEW 2021 LEXUS *IS*. ALL IN ON THE SPORT SEDAN.

 **LEXUS**  
EXPERIENCE AMAZING

[lexus.com/IS](https://lexus.com/IS) | [#LexusIS](https://twitter.com/LexusIS)



# Trump's legacy

**The invasion of the Capitol and the Democrats' victory in Georgia will change the course of the Biden presidency**

FOUR YEARS ago Donald Trump stood in front of the Capitol building to be sworn into office and promised to end “American carnage”. His term is concluding with a sitting president urging a mob to march on Congress—and then praising it after it had resorted to violence. Be in no doubt that Mr Trump is the author of this lethal attack on the heart of American democracy. His lies fed the grievance, his disregard for the constitution focused it on Congress and his demagoguery lit the fuse. Pictures of the mob storming the Capitol, gleefully broadcast in Moscow and Beijing just as they were lamented in Berlin and Paris, are the defining images of Mr Trump's unAmerican presidency.

The Capitol violence pretended to be a show of power. In fact it masked two defeats. While Mr Trump's supporters were breaking and entering, Congress was certifying the results of the president's incontrovertible loss in November. While the mob was smashing windows, Democrats were celebrating a pair of unlikely victories in Georgia that will give them control of the Senate (see United States section). The mob's grievances will reverberate through the Republican Party as it finds itself in opposition. And that will have consequences for the presidency of Joe Biden, which begins on January 20th.

Stand back from the nonsense about stolen elections, and the scale of Republicans' failure under Mr Trump becomes clear. Having won the White House and retained majorities in Congress in 2016, defeat in Georgia means that the party has lost it all just four years later. The last time that happened to Republicans was in 1892, when news of Benjamin Harrison's humiliation travelled by telegraph.

Normally, when a political party suffers a reverse on such a scale it learns some lessons and comes back stronger. That is what the Republicans did after Barry Goldwater's defeat in 1964, and the Democrats after Walter Mondale lost in 1984.

Reinvention will be harder this time. Even in defeat, Mr Trump's approval rating among Republicans has hovered around 90%—far better than George W. Bush's 65% in the last month of his presidency. Mr Trump has exploited this popularity to create the myth that he won the presidential election. YouGov's polling for *The Economist* finds that 64% of Republican voters think Mr Biden's victory should be blocked by Congress.

Perhaps 70% of Republicans in the House and a quarter in the Senate connived in his conspiracy by vowing to attempt just that—to their shame, many of them persisted even after the storming of Congress. As an anti-democratic stunt, it had no precedent in the modern era (nor any chance of success). And yet it is also a sign of Mr Trump's malign grip. After seeing how he ended the careers of loyalists like Jeff Sessions and almost single-handedly elected others, like Florida's governor, Ron DeSantis, those facing primaries remain terrified of provoking him.

The election myth that Mr Trump has spun may thus have broken the feedback loop needed for the party to change. Ditching a failed leader and broken strategy is one thing. Abandoning someone whom you and most of your friends think is the rightful president, and whose power was taken away in a gigantic

fraud by your political enemies, is something else entirely.

If something good is to come from this week's insurrection, it will be that this way of thinking loses some of its purchase. The sight of a Trump supporter lounging in the Speaker's chair should horrify Republican voters who like to think theirs is the party of order and of the constitution. To hear Mr Trump inciting riots on Capitol Hill may persuade parts of middle America to turn their back on him for good.

For Mr Biden, much depends on whether Trump-sceptic Republicans in the Senate share those conclusions. That is because the victories for Jon Ossoff and Raphael Warnock, the first African-American to be elected as a Democrat to the Senate from the South, have suddenly opened up the possibility that government in Washington, DC, will be less plagued by Republican obstruction and Trumpian stunts.

A week ago, when the conventional view was that the Senate would remain in Republican control, it looked as if the ambitions of Mr Biden's administration would be limited to what he could accomplish through executive orders and appointments to regulatory agencies. A 50-50 split in the Senate, with the vice-president, Kamala Harris, casting the tiebreaking vote, is as narrow a majority as it is possible to get. It will not miraculously let Mr Biden bring about the sweeping reforms many Democrats would like, but it will make a difference.

For example, Mr Biden will be able to get confirmation of his choices for the judiciary and for his cabinet. Control of the legislative agenda in the Senate will pass from the Republicans to the Democrats. Mitch McConnell, the outgoing Senate majority leader who spoke powerfully this week against Mr Trump's institutional vandalism, was a master of blocking votes that might

divide his caucus. That created the gridlock in Washington that voters usually blame on the president's party.

Democrats may also be able to get some measures through the Senate via reconciliation, a procedural quirk that allows budget bills to pass with a majority of one or more, rather than the 60 votes needed to avoid a filibuster, which will remain, however much the leftist wing of the party would like to drop it.

Where Republicans come in is in the scope for cross-party votes. The more they feel that Middle America was horrified by the riot, the more likely that some of them will reject the nihilism of blocking everything for the sake of it. The more their caucus is at war with itself, the freer they will be to do their part to restore faith in the republic by accomplishing something.

For Republicans, the cost of the cursed deal their party did with Mr Trump has never been clearer. The results in November provided signs that a reformed party could win national elections again. American voters remain wary of big government and have not handed one party more than two consecutive terms in the White House since 1992. But to become successful and, more important, to strengthen America's democracy once more rather than pose a threat to it, they need to cast off Mr Trump. For, in addition to being a loser of historic proportions, he has proved himself willing to incite carnage in the Capitol. ■





The pandemic

# Who gets the jab?

Answering that question will decide not only who survives, but also the sort of world they inherit

THE URGENCY of vaccination against covid-19 is growing by the day. Two new variants of the virus, spotted in Britain and South Africa, are spreading around the world (see Britain section). Although they do not seem to be more deadly, they are a lot more contagious, threatening to overwhelm hospitals with patients too numerous to be treated.

Salvation lies in rapid vaccination. However, vaccines will remain scarce throughout 2021, even as deaths mount along with the sense that protection lies tantalisingly out of reach for billions of people (see Briefing). Getting the details right could save hundreds of thousands of lives. Getting them wrong will shatter people's faith in their governments, in the benefits of public health and in the world's ability to work together.

Start with government, where accusations have already begun to fly. Although Israel had inoculated 16% of its people by January 5th, France managed just 0.01% and the Netherlands has just started. In Spain Madrid used 6% of the vials it had received; the region of Asturias administered over 80%. In America, by January 7th, the federal government had shipped 17.3m doses, well short of its target. Only 5.3m people had received shots.

Part of the explanation is structural. A small country like Israel can move ultra-cold vaccine around without it spoiling. It has a digitised health system in which patients can easily be identified and contacted. America is large and federal, and its health care is fragmented. But incompetence has also played a role. Although countries have had months to get ready, they have wasted time and made mistakes. America's federal government did not adequately fund the states to prepare for vaccination until just before the new year. In France, where anti-vax sentiment is strong, bureaucrats focused on consent instead of action. In some places vaccinations stopped or went slowly over the end-of-year holidays.

Given the lives at stake and the trillions of dollars lost to the world economy during lockdowns, governments must be creative. Open centres at night. If medical students, vets, laboratory scientists, dentists and retired medics have not been trained to inoculate, start now. Urge patients to fill out paperwork online before they arrive for a jab. Rather than threaten medics with losing their licence for breaking rules, encourage them to think for themselves. Learn from others. In 1947 New York City vaccinated 5m people against smallpox in two weeks.

Vaccination is also a test of public health. When the logistics are ironed out, as eventually they will be, the limiting factor will be how much vaccine is available. Pfizer, Moderna and AstraZeneca could provide a little over 5bn doses in 2021, enough for around 2.5bn people. More is needed, including over a billion doses of Sputnik V, from Russia, and two vaccines from China.

Both countries have offered vaccines widely, partly as tools of soft power. However, to fulfil their potential, they need to be licensed by an independent, rigorous regulator from another country or by the World Health Organisation (WHO). If countries sidestep licensing, as Argentina has with Sputnik V, too few people will trust vaccines to stop the virus. If they are licensed with-

out proper trials, as a vaccine made by Bharat Biotech has been in India, vaccination in general may be discredited.

Another way to stretch supplies is to administer more first doses by delaying the booster, as Britain and Denmark will and Germany may. Critics argue that the vaccine may be less effective, undermining confidence in vaccination, and that exposure to partially protected people may help the virus acquire resistance. Supporters say they have some evidence that delayed boosters will work and that immunology suggests people will retain plenty of protection against the virus.

To resolve this dispute requires real-world trials. Until such evidence has been collected, the WHO has rightly discouraged countries from delaying boosters except in the most desperate circumstances. Those could include the imminent collapse of many hospitals, as in Britain.

And vaccination is a test of whether the world can work together to confront common threats, such as organised crime and climate change. Developing countries have hosted clinical trials. Some of them, such as South Africa, which is undergoing a fierce outbreak, also make vaccines for multinational firms. They should share in their benefits. Modelling suggests that an optimal global distribution of vaccine according to need could save one and a half times as many lives as focusing supplies on rich countries alone. The more the virus is circulating, the more mutations there will be. Shortening the pandemic would boost the world economy. America and Europe have an interest in matching the diplomacy of China and Russia.

Early criticism about rich countries monopolising vaccines is harsh. Many ordered excess because they did not know which ones would work. The Pfizer and, to a lesser extent, Moderna vaccines require ultra-cold storage that many low- and middle-income countries lack. But by that logic, countries like Canada, which has five doses per Canadian, should release cheaper vaccines that tolerate higher temperatures, such as AstraZeneca's, as soon as they can.

In this they should work through COVAX, a mechanism for pooling the purchasing and fair distribution of vaccines. It hopes to allocate almost 2bn doses this year. Ensuring it has the money to buy them must be a priority. COVAX hopes to inoculate the world's 100m or so health-care workers by the summer. It will then need to find ways to dish out vaccine by need, which varies from country to country. A global scramble for vaccine that renders COVAX ineffective would lead to needless deaths.

## Nerd immunity

The coming months will be hard. For as long as vaccines are scarce, vaccination will be the subject of conflict and uncertainty. If it is perceived to be chaotic or unjust, it will be taken as yet another example of how elites fail ordinary people. If the rich world monopolises supplies, countries will be set against each other. Either way, people would lose sight of how, within just a year of the coronavirus being spotted, 30 countries have begun to vaccinate against it. And that, after all, is something to cheer. ■



## Cryptocurrencies

## If you can't beat them

**Bitcoin might yet justify a high price. But it will not up-end global finance**

THE FIRST surge in the price of bitcoin, to around \$1,000 in 2013, minted cryptocurrency millionaires, provoked declarations of a bubble and left some early fans kicking themselves. One unlucky man in Wales searched a rubbish dump for a hard drive containing 7,500 accidentally discarded bitcoins, whose value had grown from almost nothing to \$7.5m. Since then bitcoin has been on a wild ride. Fuelled by casual speculators and market manipulation, its price surged to about \$19,000 in December 2017; over the next year it fell by more than four-fifths. Bitcoin's most recent ascent has been its giddiest yet. Having tripled in three months its price is now over \$35,000 and somewhere under Newport sits a computer part worth over \$260m.

Today's bitcoin enthusiasm is striking because basement-dwelling libertarians are not the only ones talking it up. Some of Wall Street's finest have joined them (see Finance section). Larry Fink of BlackRock, the world's largest asset manager, said in December that bitcoin could become a "global market". Big hedge funds such as Renaissance Technologies have been punting on cryptocurrencies. Ruchir Sharma, a strategist at Morgan Stanley's investment arm, argues that America's mounting debts may make cryptocurrencies more appealing.

The total value of outstanding bitcoins exceeds that of Canadian dollars, narrowly defined to include banknotes and central-bank reserves. But few of the new crypto converts think it has any chance of replacing government money—the dream of early believers. It is far too inefficient to be of much use for making payments; bitcoin is capable of processing fewer than ten transactions per second. By contrast, the firms upending consumer finance, like Alipay and Venmo, minimise friction. Were that problem solved, governments would clamp down quickly on any technology that threatened their monetary sovereignty. Regulatory resistance has already forced Facebook's mooted digital currency, Libra, to rebrand (to "Diem") and scale back its ambi-

tion. Meanwhile, the competition is heating up as central banks improve payments systems and launch slick digital currencies of their own.

Bitcoin mania is instead rooted in the possibility that it might eventually offer a safe store of value—like gold, but more convenient (because it is easier to maintain a digital wallet than a physical vault). Then it could win a small but permanent slice of investors' portfolios. Like bitcoin, gold pays no interest or dividend. Unlike bitcoin, gold has fundamental uses, but it is fluctuating demand from investors for the yellow metal, not jewellers and chipmakers, that drives prices. It is therefore conceivable that bitcoin's high price could also prove self-sustaining. If bitcoin became as popular with investors as gold (measured by the market value of their positions) the price would rise to \$146,000, calculates JPMorgan, a bank. Already, millennial investors appear to prefer cryptocurrencies to bullion.

There are plenty of reasons to doubt that bitcoin can emulate gold. Its price is much more volatile and moves with the stockmarket, which is hardly desirable for a supposed haven. The market is illiquid and cryptocurrency trading remains a wild west in which fraud and theft are rampant, and which facilitates crimes such as selling drugs online. Investors in cryptocurrencies must tolerate a large dose of financial and reputational risk. Hedge funds, which thrive on dicey investments, may be piling in but the stolid end of Wall Street, which includes pension funds, is wary.

Yet it would be wrong to dismiss bitcoin's surge out of hand. Eventually, an accommodation with regulators, more liquid trading and clampdowns on criminal activity—the supposed anonymity of bitcoin is overstated—could give it a wide appeal. Bitcoin was originally sold on the promise of upending the global monetary system. Its success now hinges on finding a more modest role within it. ■



## Encyclopedias

## Diderot's dream

**In praise of Wikipedia**

WIKIPEDIA IS CLEAR on the matter: Wikipedia is not a reliable source. Yet on this particular question, few people seem to agree with the world's most popular encyclopedia. The site approaches its 20th birthday, on January 15th, as the 13th-most-visited place on the web, offering more than 55m articles written in 300 languages. Worries about fake news, filter bubbles and market power have soured public opinion on the Utopian promises of the early internet. But Wikipedia—written by amateurs, freely available to all—stands as the great exception. It is the dream that worked.

Or at least, mostly worked. Wikipedia's crowdsourced model

remains vulnerable to the occasional hoaxer or chancer. In August it emerged that many articles on the Scots version of the site had been written by an American editor who, by his own admission, was not really a speaker of the dialect. Nor is it free from honest mistakes. That can cause problems: for better or worse, powerful platforms from social-media firms to the World Health Organisation have come to treat it as a wellspring of truth online (see International section). All the same, the world is much better off for its existence.

Indeed, familiarity may have dulled the scale of its achievements. As well as being roughly as accurate as old-style encyclo- ▶

pedias, Wikipedia is also incomparably broader. Curious readers can learn about worthy subjects like Homer, general relativity or the Taiping Rebellion. They can also read about Québécois slang, the nature of magic in the “Harry Potter” novels and the fortunes of Yeovil Town Football Club, which toils in obscurity in the fifth tier of the English league. Denis Diderot, the 18th-century editor of the French *Encyclopédie*, hoped to “assemble all the knowledge scattered over the face of the Earth”. Wikipedia would have delighted him.

The project owes much of its success to its unique structure. Funded by donations, Wikipedia earns no profits. It has no venture-capital backers demanding growth at all costs. Without advertisers to satisfy, it can focus exclusively on the interests of its readers and contributors. It is curated and run by people, not machines. There is no recommendation algorithm humming away in the background, choosing what to show readers in order to keep them glued to the site for as long as possible.

Other tech titans should study its success. Relying on algorithms is one reason they have achieved enormous scale with so few employees. Yet the downsides have begun to haunt them. As the social-media giants hire ever more people as moderators, and write ever longer sets of rules about what is allowed, Wikipedia offers a lesson in how to run a human-powered website.

It is also a welcome boost for Enlightenment values, which

have suffered at the hands of populism and authoritarian capitalism. If Wikipedia’s occasional scandals make people approach it with a little scepticism, all the better, for fair-minded scepticism is a healthy attitude in general. Wikipedia sees itself as a work in progress. If a fact is wrong, it invites users to persuade others so that it can be corrected. Its internal culture holds that knowledge comes from evidence, reason and good-faith debate, not pronouncements from the pulpit or the party.

Like any institution, Wikipedia has flaws. It sometimes fails to live up to its own ideals. The nature of crowdsourcing means its quality varies. The most popular articles receive the most scrutiny, and tend to be the best. That leaves a long tail of obscure entries of lower quality. Articles can be overlong, or too technical. Much of its magic comes from the distinctive culture that has built up among contributors—but cultures can be fragile.

Perhaps its biggest flaw is that, for all its breadth, it is still too narrow. The site’s editors are mostly male, and mostly from North America and Europe (see Graphic detail). A small number do a disproportionate share of the work. That colours both the encyclopedia’s choice of entries and the way it covers them. Wikipedians have been trying to change that, but progress has been too slow. A lot is at stake. In rich, liberal countries, where information is widely available, Wikipedia is a convenience. In poorer places, and illiberal ones, it can be quietly revolutionary. ■

### Dealing with China

## Advantage, Beijing

### Arrests in Hong Kong and Europe’s dubious trade deal show that the West is on the defensive

THE WORLD’S democracies desperately need a coherent approach to dealing with China. It is the 21st century’s ascendant power, but also an autocracy that mistrusts free markets and abuses human rights. However, recent events show how ineffective Western policy has become. On December 30th the European Union agreed on an investment pact with China that secured puny gains and gave China a diplomatic coup. The EU did so despite doubts among Joe Biden’s team (see Europe section). New York’s stock exchange banned several Chinese firms’ shares, only to change its mind twice in a few days. Congress has so far failed to pass a bill to protect Uyghurs from forced labour (see United States section).

As the West stumbles, China is busy cracking down at home and expanding its influence abroad. On January 6th more than 50 democracy activists were arrested in Hong Kong (see China section). In November China signed a trade pact with 14 Asian countries, including American allies such as Japan and Singapore. It continues to threaten Australia with its thuggish diplomacy and a partial trade embargo.

The pattern of Chinese assertiveness and Western disarray has become all too familiar. All democracies are struggling to reconcile the conflicting objectives of doing business with a huge and vibrant economy, and protecting national security and human rights (see Chaguan). The Trump administration skewered Western complacency about China’s state-led model, but then detonated the global trading system without proposing an alternative. Rich countries have failed to act together, reducing

their clout. America’s negotiators identified structural reforms that China should enact, and that other Western powers might have supported, but in the end President Donald Trump won only small concessions in the “phase one” trade agreement struck with China in January 2020. Western policy has become a muddle of deals, rebukes, ad hoc bans and tariffs. The system of rules that has been the backbone of global commerce for decades—featuring open trade and capital markets, and impartial legal systems—thrived because it was predictable. Not any more.

China is exploiting the disarray even as its economy comes roaring back from the pandemic: year-on-year growth was 4.9% in the most recent quarter. Beijing’s rulers expect Mr Biden’s administration to be preoccupied with America’s troubles at home, not least covid-19. Europe has welcomed Mr Biden’s conciliatory noises, but worries that his policies are laced with protectionism, including “Buy American” clauses and ambiguity over whether tariffs will be removed.

Faced with an introspective superpower, the EU decided to speed up its long-standing effort to strike an investment deal with China. When it acts in isolation, however, it doesn’t have much sway. The new deal features assurances over Chinese state meddling in industry that will be tricky to enforce and platitudes on human rights that China will ignore.

What might a coherent policy look like? It has to start by acknowledging China’s power. Unlike the Soviet Union, China is too big and interconnected to contain. It accounts for 18% of world GDP. It is the largest merchandise trading partner of 64





# ONE OF THESE PEOPLE DOESN'T EXIST



Malicious AI created her picture, yet she has never been seen by a camera. It made her an online profile, yet she has never logged in.

Malicious AI built her to attack you.  
**Now it's time for AI to fight back.**

[darktrace.com](https://darktrace.com)

 **DARKTRACE**  
World-Leading Cyber AI



▶ countries, including Germany (see Business section). America's tally is just 38. Chinese capital markets are becoming important, too. Foreigners now own up to 10% of all government bonds. Yet for all China's size and sophistication, relations will remain riven with mistrust. It is hard for outsiders to tell if private firms are acting independently of the Communist Party. And it is foolhardy to rely on Chinese government promises, whether on subsidies for industry or the rule of law in Hong Kong. The result is that in some domains the West should seek to confront China (human rights), while in others it should compete (most areas of trade) or co-operate (health and climate change).

The sheer complexity of trading without trust amplifies the need for the West to act in unison to maximise its influence. Together, America, Europe and other democracies still account for over half of world GDP. In order to limit the perimeter of trade tensions, they should define sensitive industries, such as technology and defence. In these areas they should subject Chinese participation in Western markets to much tighter scrutiny and

restrictions. In other industries trade can flourish unhindered. Democracies should draw up a common framework for human rights, including verifying that supply chains are ethical and penalising people and firms involved in abuses. Finally, any new alliance to deal with China has to have predictable rules and enforcement. It cannot be run from the White House on the fly.

Even before Europe's snub this was a daunting task for the incoming Biden administration, on a par with the creation of NATO or the world trading system after the second world war. And unlike back then, America's prestige has been battered. Yet public opinion in the rich world is now wary of China. Mr Trump failed to deal with it partly because of his incompetence and contempt for allies. Mr Biden will take office on January 20th on a wave of global goodwill. It should be possible to create a grouping of democracies, for example an enlarged G7, that will act on China. There is still a chance to reassert the values of open societies and free markets, but it will not last for ever. Faced with an assertive autocracy, dithering and division are not enough. ■

### Democracy in Africa

## Time out

**Many African countries are letting presidential term limits slip. That's a shame**

THE PASSING of time improves many things. Friendships mature and deepen with the years. Fond memories become sweeter and bitter ones mellow. Presidential terms, however, rarely get better the longer they last.

Take the case of Yoweri Museveni, who has run Uganda since 1986. Not content to retire to his farm, the 76-year-old is standing for yet another term in elections scheduled for January 14th. Mr Museveni is not the longest-serving president in Africa. That dubious record is held by family dynasties such as the Gnassingbés in Togo, the Obiangs in Equatorial Guinea and the Bongos in Gabon, who have ruled their countries for more than five decades, or by men such as Paul Biya, who has held the reins in Cameroon for nearly four decades (and was prime minister before that). Mr Museveni is not far behind. His 35 years in office show how leaders who start with much acclaim can look soiled when they stay too long.

After Mr Museveni took power he was applauded by Western governments and donors for bringing peace, holding elections, liberalising the economy and promising free speech. His candour and willingness to admit mistakes were especially refreshing. Yet after more than three decades in charge he has become a caricature of the thin-skinned autocrat. In 2017 he jailed an academic, Stella Nyanzi, for taking to social media to call him "a pair of buttocks". His police arrest, shoot and torture opposition activists and journalists. Repression is intensifying ahead of the election, as he faces a popular young musician-turned-politician who goes by the stage name Bobi Wine. There is no chance of a fair election. Uganda is a compelling example of why it is so important that countries set term limits and then stick to them.

In 1990 almost no country in Africa had set a constitutional limit to the length of time a president could serve. When Nelson Mandela stepped down after his first term as president of South Africa he hoped to set an example for the continent. It was widely

followed. Of almost 50 new constitutions passed during Africa's wave of democratisation in the 1990s, more than 30 limited the number of terms a president could serve. On paper more than three-quarters of sub-Saharan African countries now have such limits. But a depressingly large number of leaders have backtracked. Uganda under Mr Museveni dropped the law in 2005 and lifted an age limit in 2017. Since 2015 the leaders of no fewer than 13 African countries have sidestepped or weakened term limits, according to the Africa Centre for Strategic Studies, which comes under America's Pentagon.

Many Africans say it is racist to lecture them about term limits when countries such as Russia and China have abolished theirs recently, too. Many Western leaders, including Angela Merkel, Germany's chancellor since 2005, face no restrictions. Democracies everywhere might well be healthier if they insisted on periodic changes of the person in charge. But many African countries risk seeing incumbents accumulate too much power and then refuse to be dislodged at the ballot box. The danger is severe there because the checks and balances that reinforce democracy, such as electoral commissions, independent courts and free media, are often weak and easily subverted. The consequences of leaders who overstay their welcome are starker in Africa, too. Nine of the ten countries involved in civil wars in Africa lack term limits, says the Africa Centre. Those without them tend to be more corrupt.

That is why most African countries chose to put limits into their constitutions, even if many current leaders now wish to ignore them. Peer pressure could help keep them honest. In the past 20 years Africa has had far fewer coups than in the preceding decades, partly because plotters know they will face sanctions from the African Union if they grab power illegally. If the union also imposed sanctions on leaders who break term limits or rig elections, democracy in Africa would have more of a chance. ■







The Leibniz Institute for Financial Research SAFE – Sustainable Architecture for Finance in Europe – promotes high-quality research and independent policy advice on all aspects of the financial system. It has the mission to contribute to a sustainable and resilient financial architecture that promotes innovation and serves the needs of the economy and the society. Scholars from Finance, Macro- and Microeconomics, Law, Political Science, and Sociology join their forces at SAFE.

Based on a joint selection process, SAFE and the Faculty of Economics and Business at Goethe University Frankfurt invite applications for the following position as civil servant or public employee starting at the earliest possible date:

**President (“Scientific Director”)  
of the Leibniz Institute  
for Financial Research SAFE  
combined with a  
Professorship (W3) of Finance**

The Scientific Director represents the Leibniz Institute SAFE externally and chairs the three-member Management Board which runs the Institute’s day-to-day operations. As SAFE pursues a cooperative governance approach, the Scientific Director is responsible for all academic matters together with the Deputy Scientific Director and in close cooperation with the Scientific Board consisting of the Directors of all SAFE research departments. The Scientific Director will simultaneously lead one of the SAFE research departments.

For the position announced we are seeking an internationally recognized individual with a strong and active research profile (publications in top journals in the last 5 years) who will dynamically develop the Institute and its interdisciplinary orientation together with the other members of the Management Board and the Scientific Board, the Board of Trustees, the Research and Policy Advisory Councils and all employees.

We are seeking a Financial Economist who is distinguished by her/his academic achievements in one of the core fields of Finance, and who has several years of experience in managing a research institution/unit and leading a large team. A high degree of creativity, an innovative mindset and the ability to work in a team are just as necessary as strong leadership, management, communication and integration skills in order to meet the diverse challenges of the position. Experience in policy advisory activities and in dealing with media representatives is expected.

For further information on the advertised position and the application requirements, please see:

[www.safe-frankfurt.de/announcement\\_president](http://www.safe-frankfurt.de/announcement_president) and  
[www.vakante-professuren.uni-frankfurt.de](http://www.vakante-professuren.uni-frankfurt.de)

**WWW.UNI-FRANKFURT.DE**

# A MISSION LIKE NO OTHER

## The Central Intelligence Agency

The Central Intelligence Agency seeks high-performing, patriotic professionals with a diverse range of backgrounds, skill sets, and life experiences to serve the United States by advancing the Agency’s mission as the nation’s first line of defense. We are interested in candidates available for full-time, part-time, and consulting opportunities both at home and overseas.

For the intellectually curious adventurer looking for an unparalleled, high-impact international opportunity, we offer a way of life that challenges the deepest resources of an individual’s intellect, resilience, and judgment. While no specific work background is required, candidates with experience in business, entrepreneurship, sales, marketing, real estate, and program management are highly desirable.

### Competitive candidates should possess the following:

- US citizenship, dual US citizenship, or US Lawful Permanent Resident (LPR) status
- 3+ years of international experience
- The desire to live, travel, and work abroad
- Foreign language skills
- The ability to successfully complete medical and security processing

**Individuals must be physically located in the US to apply.**

Take the next step. Mail your résumé with a cover letter to:

**Recruitment Center  
Box 26  
Dept. D-45  
Washington, DC 20505**



THE WORK OF A NATION.  
THE CENTER OF INTELLIGENCE.

*The CIA is an equal opportunity employer and a drug-free workforce.*





## Tell me a secret.

The Secret Intelligence Service, also known as MI6, seeks individuals with diverse skill sets and life experiences for part-time and consulting roles to enhance our core mission. We work in challenging and volatile environments in the real world and online, with a focus on national security, economic well-being, and the prevention or detection of serious crime.

Highly desirable individuals could be subject matter experts in their chosen field or come from a range of professional backgrounds. We welcome applications from UK and foreign nationals alike. To learn more about available opportunities, please send your curriculum vitae and covering letter to:

Recruitment Department, PO Box 77100, London SE1P 6NB

Please do not disclose to anyone that you have contacted MI6. Doing so may mean that we cannot progress your application. Candidates will have to pass a vetting process.



## Develop the corporate communications strategy for the premier development bank for Latin America and the Caribbean.

### Strategic Communications Unit Chief Washington DC

With 48 member countries, the IDB has been a leading source of long-term finance and development knowledge for Latin America and the Caribbean for more than 60 years. You will take ownership of the Strategic Communications Unit at the heart of our Knowledge, Innovation and Communication Sector.

In addition to shaping the corporate communications strategy, you will oversee the production of speeches, opinion columns, video scripts and news releases, and coordinate crisis communications. This will require extensive experience in corporate communications, both internal and external, with a strong technical background and a highly strategic mindset. Significant exposure to Latin American and Caribbean countries would be highly advantageous, but more importantly you will be an effective programme manager, creative thinker and business leader, with full fluency in English and Spanish (ideally backed by some command of French or Portuguese).

To apply, please go to  
<https://iadbcareers.referrals.selectminds.com/>  
Closing date: 14 January 2021.

At the IDB, we offer a competitive remuneration and benefits package, including full relocation, if applicable.



Jane Leighton  
BEFORE CREATIVE INDUSTRIES  
NOW MATHS TEACHER

# ARE YOU READY FOR A CHANGE?

Come back to school  
[nowteach.org.uk](http://nowteach.org.uk)



## The African Legal Support Facility Director/CEO

The Management Board of the African Legal Support Facility (ALSF) intends to appoint a new Director and CEO in view of the imminent completion by the current Director of the statutory terms as provided under the ALSF Treaty. The new Director will build on the considerable achievements of ALSF to date and champion its ambition to remove asymmetric technical capacities and level the field of legal expertise among parties to litigation and negotiations.

ALSF is an international organization established by Treaty on December 22, 2008. Its membership is open to (a) all African Development Bank (AfDB) member states; (b) other states; (c) AfDB; and (d) other international organizations or institutions. The Facility currently has 60 members, comprising 53 countries and 7 international organizations. ALSF's main objectives include: (i) assisting AfDB's Regional Member Countries (RMCs) to address litigation brought against them by vulture funds (and other such entities); (ii) creating an avenue for AfDB's RMCs to access technical advice when negotiating complex commercial transactions (especially in the area of infrastructure and natural resources); and (iii) investing in and organizing the training of legal counsel from RMCs to equip them with the legal expertise necessary to better represent their countries. The ALSF also develops and proposes innovative tools for capacity building and knowledge management.

Since its inception in 2010, the Facility has supported African governments in negotiations of commercial agreements of a cumulative value of over US \$60 billion and more than 8,000MW of energy projects. Currently it is assisting African States on more than 110 projects, with over 70% of the projects related to advisory services for either direct assistance in contract negotiation or the building of legal foundations needed to properly negotiate contracts.

The Director will require proven leadership and management skills, as well as experience in high level resource mobilization and fund raising amongst governments, supranational organizations, bilateral and multilateral bodies, amongst others. The ideal candidate will bring a demonstrated track record of extensive and progressive experience in international commercial law.

ALSF has retained Russell Reynolds Associates to assist with this appointment. For further information on the position and additional details on qualifications, requirements, terms and conditions of service and how to apply, please visit: [www.rraresponses.com](http://www.rraresponses.com)

The closing date for applications is 22nd February 2021.

The African Legal Support Facility is an equal opportunity employer and female candidates are strongly encouraged to apply.





### The usefulness of subterfuge

Military deception is indeed a lost art in democracies, and more's the pity ("Bodyguard of lies", December 19th). Yes, it exists at a tactical level ("I'll make the enemy think that I'm attacking from the right but actually my main force will be on the left"), but this is entirely predictable in its repetitiveness. At the more strategic level, military deception has withered. D-Day succeeded because of the trickery you mentioned: reinforcing Hitler's conviction that Pas-de-Calais, 300km from Normandy, was the target for the Allied landing. Such deception would be impossible now. Modern armed forces are not nearly large enough to have the flexibility for such a duplicitous task. Conversely, headquarters' staffs are too bloated, making it more probable that deception strategies would leak out.

Advances in reconnaissance technology need to be matched by advances in deceptive thinking. For example, radio silence makes an object stand out in a cluttered electronic background, rather than be hidden, in the same way that a soldier wearing camouflage is obvious on a city street. And some thinking needs to come full circle. Dazzle-painting ships in the first world war, to mask their aspect and thereby hinder attacking submarines, can have the same effect against new electro-optic anti-ship missiles. But nobody is doing this.

The clearest word goes to Arthur Ransome's "Swallows and Amazons". One of the children says that the key to success is knowing exactly what we want to achieve, and doing it in the way the enemy least expects. The problem with democracies now is not knowing exactly what it is that they want to achieve.

CHRIS CLOUGH  
Paris

Churchill described the fall of Singapore in February 1942 as the "worst disaster" in the history of British warfare. General Arthur Percival erred

in concentrating British defences along the broader north-eastern side of the island, disregarding warnings that it would be attacked from the north-west where the Straits of Johor were narrowest. Percival was bluffed by General Yamashita when the Japanese invaded through the causeway into Singapore. His humiliating, unconditional surrender painfully marked the beginning of the end of the British Empire in Asia.

JOHN DRISCOLL  
Singapore

### Protesting in Singapore

It was to be expected. A man is charged in Singapore for staging a protest without a permit, and your headline proclaims: "A city reels" (November 28th). But here are some inconvenient facts. The activist, Jolovan Wham, could have protested at Speakers' Corner in March 2020 without a police permit, but chose not to do so. You are mistaken that Speakers' Corner was closed at the time; it was closed from April because of the pandemic. And urging action against climate change is not deemed "subversive" in Singapore. One of the largest demonstrations held in Singapore in recent years was the Climate Rally in September 2019. This occurred at Speakers' Corner, without incident. Mr Wham's protest did not elicit mass sympathy. He succeeded only among his small target audience, which includes *The Economist*. His aim was to underline Singapore as a punching bag in the Western media.

Singapore is not reeling though. Citizens appreciate an orderly and safe city where they regularly express their views within the law. *The Economist* may wish that Singapore becomes more like its former colonial master Britain, which, however, also has its own difficulties. Singapore's system is not flawless, but we will find our own path forward.

T.K. LIM  
High commissioner for Singapore  
London

### Europe's centre-right parties

Charlemagne missed a crucial point about Christian Democrats (December 19th), which is their appreciation of Catholic social teaching's subsidiarity principle. What the family can handle should be left to the family. What local government can handle should be decided at that level. National governments should have jurisdiction over only those things that lower level authorities cannot handle. The implication is that there are things that supra-national authorities may be useful for. Accordingly, it makes sense to pool sovereignty for purposes of that kind.

That is Christian Democrats' real difference with Britain's Tories, who have centralised national power, weakened subnational institutions and left the EU. The Johnson government has no serious proposals for how the world can provide and safeguard international public goods. We face daunting global challenges: global warming, covid-19, trade relations, financial stability, terrorism, dwindling biodiversity, mass migration, and so on. Insisting on undiminished national sovereignty does not help. By contrast, sensible application of the subsidiarity principle could work, at least in theory.

HANS DEMBOWSKI  
Frankfurt

### Courageous Cubans

"The art of dissent" (December 5th) provided an excellent overview of the clash between the state and a growing civil society in Cuba. One quibble. You suggest that Cubans show little interest in supporting dissidents or demanding more freedoms because they are too busy scavenging for food, then imply that a more lenient American embargo might ease shortages and encourage Cubans to be braver. That is rather simplistic.

Shortages of food in Cuba are as chronic as political repression, a consequence of domestic policies that always prioritise political power over

all else. For six decades Cubans have been terrorised by a totalitarian state that is as efficient in its repression as it is incompetent in its handling of the economy. Cubans are wary not because they are hungry or busy, but because they are afraid. As the San Isidro Movement shows, this is beginning to change regardless of scarcity or American policy.

SEBASTIAN ARCOS  
Associate director  
Cuban Research Institute  
Florida International  
University  
Miami

### Is it the way I talk?

Johnson's suggestion that accent snobbery is irrational and would be cured by more education betrays a curious conception of both reason and education (December 12th). Like all kinds of snobbery, accent snobbery sends a signal that one is an insider. Nothing irrational about that in a world where people respond to signals and being an insider can make all the difference. And like that most refined form of snobbery—looking down on others because they are not as egalitarian as you—accent snobbery is entirely the product of education.

JOHN SEXTON  
Chicago

### Financial giants

We all know what happened to Goliath when he encountered a kid with a slingshot. So I hope when you referred to JPMorgan Chase as "a banking Goliath" ("Capital punishment", December 12th), you really meant Gargantua, who was rich. If not, it would cause Jamie Dimon no end of distress. Me too, since I hold some of their debt.

BUDD WHITEBOOK  
Washington, DC

Letters are welcome and should be addressed to the Editor at The Economist, The Adelphi Building, 1-11 John Adam Street, London WC2N 6HT  
Email: [letters@economist.com](mailto:letters@economist.com)  
More letters are available at: [Economist.com/letters](https://www.economist.com/letters)





## The great task

BEIJING, LONDON, PARIS AND SÃO PAULO

**The race to vaccinate the world against covid-19 has begun in earnest, posing problems for many and providing opportunities for some**

**B**RAZIL SEEMS the sort of place where vaccination against covid-19 should have taken off quickly—and not just because it is suffering heavily from the disease. Impressive vaccine-making institutes—Butantan in São Paulo and Fiocruz in Rio de Janeiro—provide excellent support for its existing immunisation programmes. Natália Pasternak, a microbiologist at the University of São Paulo, says that if it had put its mind to it, her country could have developed a vaccine all of its own.

Even though it did not take that route, Brazil has been intimately involved in the validation of covid-19 vaccines developed elsewhere, hosting four phase-three trials—in part, alas, because the high infection rate meant such trials could expect fairly quick results. One might have thought that would put the country first in line for deliveries. But as of the first week of January Brazil, a country of 212m, had just 6m doses of a covid-19 vaccine within its borders. Because that vaccine has yet to be approved by the country's regulators, not

one dose has been used.

Since December three covid-19 vaccines made by Western companies have been approved for use by regulatory bodies that the World Health Organisation (WHO) considers “stringent”. American and European regulators have endorsed two vaccines, one created by BioNTech, a German biotech company and produced by Pfizer, an American pharmaceutical firm, and one made by Moderna, an American biotech company. A vaccine created at Oxford University and produced by AstraZeneca, an Anglo-Swedish pharmaceutical firm, has been approved in Britain and India—the country which produces most of the vaccines used in developing countries. Vaccines made by Russia and China have also been authorised for use in their home countries and some others (see chart 1 on next page).

For there to be any vaccines, let alone a plethora of them, less than a year after the first cases of covid-19 were reported is an unprecedented achievement. It also brings new challenges. In rich countries, where

most of the vaccine development went on and was paid for, these are primarily in manufacture and distribution: how to manage the logistical task of getting vaccines into the right people as fast as possible. Middle-income and poor countries face problems of acquisition. And everywhere disparities within and between countries are highlighting pre-existing inequalities and political dysfunction.

Brazil's plight shows the damage that politics can do. The president, Jair Bolsonaro, has consistently mocked and minimised concern about covid-19. In early June João Doria, the governor of São Paulo, signed a deal with Sinovac, a Chinese biotech company, to host phase-three trials of its CoronaVac vaccine in his state; the deal gave the state 6m doses and the right to make 40m more at the Butantan Institute in São Paulo. Mr Bolsonaro, who had ignored overtures from vaccine-makers, scoffed at his rival's move and poured scorn on the Chinese vaccine. In late July the central government did order 100m doses from AstraZeneca. But it is not as yet approved in Brazil, and production there, which will be handled by Fiocruz, will take months to certify and ramp up.

“No health secretary could imagine in his worst nightmare that this could happen,” says Fábio Vilas-Boas, the health secretary of Bahia, a state of 15m people in Brazil's poor north-east. It is among dozens of cities and states that are following São Pau- ▶▶

► lo's lead in negotiating directly with vaccine-makers to guarantee supplies. Bahía has agreed to host trials of Sputnik V, a vaccine developed in Russia, in exchange for priority access to 50m doses. A group of private Brazilian clinics has agreed to buy 5m doses of Covaxin, an experimental vaccine developed by India's Bharat Biotech which, to the surprise of many, was recently given approval for emergency use by Indian regulators.

This disturbing public-health scavenger hunt reflects a more general dynamic. The demonstrated efficacy of the three vaccines developed by Western pharmaceutical companies has made vaccination feel like an urgent possibility around the world, especially in middle-income countries like Argentina, Brazil, Indonesia and South Africa. But supplies of those vaccines have, by and large, been snapped up by the countries where they were developed and their rich-world neighbours.

What is more, two of those vaccines, the ones from Pfizer-BioNTech and Moderna, are delicate enough to require special treatment—and also pretty expensive. Seth Berkley, the boss of Gavi, a public-private initiative that distributes vaccines in low-income countries, says that outside the rich world the Pfizer-BioNTech vaccine is likely to be used only in very small populations, such as health workers in big cities.

It is the AstraZeneca-Oxford vaccine that has the most to offer the world at large. It is cheaper and more robust, and the expertise needed to manufacture it is reasonably widespread. There are plans for it to be manufactured at nine "nodes" around the world, allowing a great deal to be made. The node that matters most to Dr Berkley is that in South Korea. It will be producing the vaccine for COVAX, a consortium set up by Gavi and others that is devoted to providing covid-19 vaccines around the world.

Unfortunately, only the nodes in Britain and India have so far received regulatory approval and started production, and most

of their production is slated for domestic use. Regulatory approval for the others, including Fiocruz in Brazil, may take some time. Dr Berkley expects approval for the South Korean node to take 40 days. After that the WHO will still have to weigh in before COVAX can get moving.

In a world where the supply of a cheap Western vaccine along these lines was already plentiful there would be little interest in the less well-attested vaccines from China, India and Russia. As it is, they provide a welcome option for some countries, as well as a fillip for their originators (see chart 2 on next page).

China and Russia see their vaccines as offering a boost to their prestige and soft power as well as providing them with trade and diplomatic opportunities. China wants to "project a narrative that it's taking care of countries that have been left behind," says Oliver Stuenkel of Fundação Getulio Vargas, a university in São Paulo. This kind of vaccine diplomacy could shape the geopolitics of 2021 and beyond.

### Sigue Sigue Sputnik

In August Vladimir Putin, Russia's president, announced that the Gamaleya Centre in Moscow had developed the world's first covid-19 vaccine: its precedence was underlined by naming it Sputnik V, a reference to the epoch-making satellite launched by the Soviet Union in 1957. As Elena Amelina, who runs a research laboratory at Russia's Pulmonology Research Institute, explains: "The goal was not just to produce a working and reliable vaccine, but to be seen as being ahead of the planet—as if it was an arms or a space race."

The analogy, though, had a fatal flaw. No one doubted there had been a great leap forward when the Soviet Union launched the world's first satellite: the pings Sputnik gave off as it circled Earth could be picked up on transistor radios. When it came to Sputnik V, though, you had to take Mr Putin's word for it. The need for a speedy an-

nouncement had not allowed time for full trials; the data were scanty.

The Russian government thinks perception is everything. The human immune system takes a different view, and independent regulators try to follow its lead. The lack of reliable trial data prevented any acceptance of Sputnik V in the West. The same was true for the Sinovac vaccine which Chinese authorities approved for emergency use in August, and the vaccine from Sinopharm approved for general use there in December.

This does not mean that those vaccines do not work; just that they had not been shown to do so when first approved. Since then trials in various places have persuaded some regulators in other countries that the non-Western products are worth buying and safe enough to use. Others are waiting for further trials to report before taking the plunge.

In Bahrain, which has the second-highest vaccination rate globally, people have enthusiastically taken to the Sinopharm vaccine after supplies of the Pfizer-BioNTech jab ran low; trials in the UAE have found it to have an 86% efficacy rate. Trials in Turkey and Indonesia suggest that CoronaVac provides protection, but data on its efficacy remain thin. Indonesia has since started vaccinating people of working age with CoronaVac—though not older people, because the data do not as yet seem to support it. The results of the São Paulo CoronaVac trial, which were due after *The Economist* went to press on January 7th, are eagerly awaited beyond Brazil.

Other forms of approbation are also available. Sputnik V is similar in its design to the AstraZeneca-Oxford vaccine—both use a harmless adenovirus to deliver a genetic transcript describing SARS-COV-2's spike protein—and in December AstraZeneca and the Gamaleya Centre agreed to work on trials that combine the two vaccines. Dr Amelina sees this as a chance for the Russian vaccine to improve its reputa- ►►

## Hope in a vial

Covid-19 vaccines, to January 6th 2021 Approved by: ● Stringent regulators ● Other regulators

Producer	Name	Type	Price per dose, \$*	Doses delivered in 2020 and promised for 2021*	Approved in
● AstraZeneca-Oxford University	AZD1222†	Viral vector	1.50-4	3.0bn in total	Britain, India and 3 others
● Novavax	NVX-CoV2373	Protein subunit	16	2.1bn	–
● Pfizer-BioNTech	tozinameran	mRNA	19.50	1.4bn	Britain, EU, US and 21 others
● Sinopharm	BBIBP-CorV	Inactivated	<77	1.3bn	Bahrain, China, Egypt, UAE
● Gamaleya Centre	Sputnik V	Viral vector	<10	1.0bn	Argentina, Belarus, Russia
● Johnson & Johnson	JNJ-78436735	Viral vector	10	1.0bn	–
● Sinovac Biotech	CoronaVac	Inactivated	14	900m	China
● Moderna	mRNA-1273	mRNA	32-37	770m	Canada, EU, Israel, US
● Bharat Biotech-ICMR	Covaxin	Inactivated	1	720m	India
● CureVac	CVnCoV	mRNA	12.30	300m	–

Sources: Regulatory Affairs Professionals Society; The Economist Intelligence Unit; Morgan Stanley; press reports; government websites; company websites

\*Estimate †Covishield in India



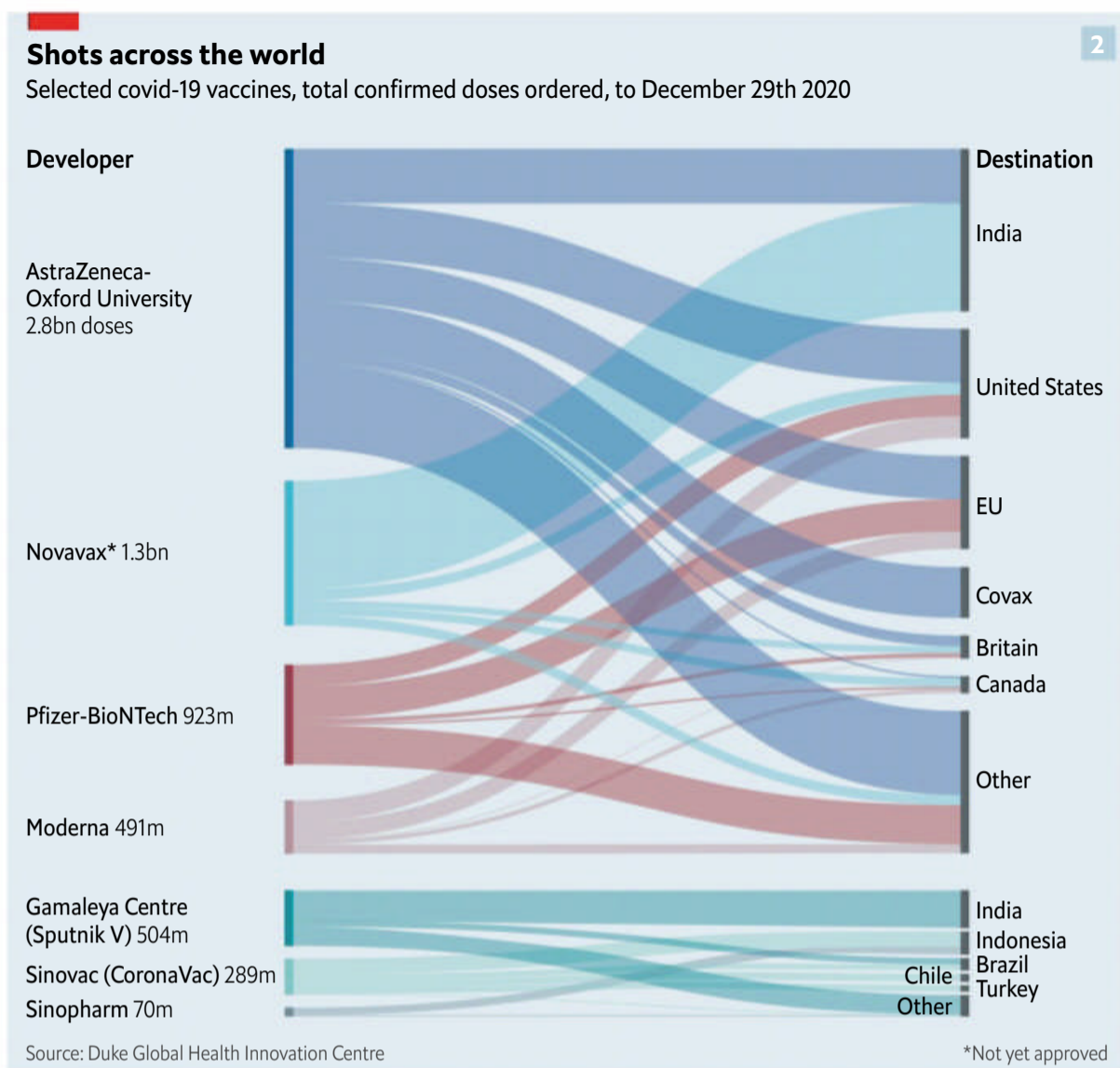

tion, a view echoed elsewhere; Russian state media, meanwhile, have portrayed it as the West coming begging for help. If further investigations work out well, it is possible that the vaccine will end up more warmly received abroad than at home, where in December 58% of the Russian people, used to being lied to, told pollsters they would be unwilling to take it.

There is domestic hesitancy in China, too—and not without reason. The country has a long history of vaccine scandals. But the 1.5m vaccine doses that were distributed last year did not all go to people obliged by the government to take them, such as soldiers, party officials and labourers being sent abroad; some of the rich and well connected happily snagged doses for themselves. Mass vaccination programmes are now being introduced with ambitious goals but no great sense of urgency. The number of cases of covid-19 is tiny and life is close to normal.

### Europe's regiments

It is possible that in time Western governments will increase the amount of vaccine available to others. Many ordered more than they needed from various suppliers in order to be sure that they would get their hands on at least one that worked (see chart 3 on next page). Canada has dibs on enough doses to immunise 505% of its population; Britain and America have coverage of 290% and 200%, respectively. When they feel as-

sure of a supply that will meet the needs of their fully up and running vaccination programmes, such countries will probably redirect what is surplus to requirements.

At the moment, though, a fully up-and-running programme is a rarity. This is particularly true in continental Europe, where vaccine roll-out has been much slower than in America and Britain (let alone Israel, which is leading the world). One reason seems to be that the European Medicines Agency (EMA) is giving conditional approval for the vaccines, rather than simply authorising their emergency use. This higher standard has benefits, including not having to indemnify suppliers against lawsuits, but requires more data and takes more time. American and British regulators have been quicker.

Another problem is that the EU, acting as a bulk purchaser for its member states, plumped much more heavily for AstraZeneca's product than for Pfizer's—and the EMA has yet to approve the AstraZeneca-Oxford vaccine. The EU also ordered a lot of the vaccine being developed by Sanofi, a French pharmaceutical company, in collaboration with GSK, a British one. Unfortunately, trials showed this vaccine to be poor at generating immunity in older patients. A new formulation may well put matters right. But it is unlikely to be approved and available much before the end of the year.

The final reason for low vaccination rates in Europe has to do with planning, lo-

gistics and the availability of appropriate workers. Most of the planning did not envisage the urgency which soaring case rates have added to the first weeks of the campaign. France's plan, for example, involved repeated medical visits to ensure care-home residents gave informed consent, a time-consuming step which in the current circumstances has driven frustration. The speed of action varies not just from country to country but also from region to region. Some bits of Italy have already administered more than three-quarters of their initial allocation of vaccine. Others have barely managed a third of that.

The pace of vaccination may improve as a sense of urgency works its way through the system. President Emmanuel Macron has berated French ministers and health authorities, repudiating their public calls for patience as vaccination programmes are ramped up. Jens Spahn, Germany's health minister, has put pressure on the EMA to pick up the pace. A fresh order of the Pfizer-BioNTech vaccine is in the works.

America is doing better. Even so, only about a quarter of the 17m doses distributed up to January 5th were recorded as having been used by that date. Even allowing for a reporting lag, that means many sit untouched in the freezers. One reason is that a lot of planning focused on cold-storage capacity—needed by both Pfizer-BioNTech and Moderna vaccines—rather than actual administration. “We should have been focusing on ‘How many can you vaccinate today, tomorrow, the day after?’,” says Claire Hannan of the Association of Immunisation Managers.

Some states and cities are now adopting what California's governor Gavin Newsom has called a “much more aggressive posture” in order to get vaccines used. His state is working to set up more vaccination sites, to enroll the National Guard to help and to allow dentists, pharmacists and other health professionals to do the jobs. Some states are drawing up rules whereby vaccines a health-care provider does not use after thawing are reallocated. Some other states in which health-care providers are not getting through all the vaccine allocated to them, including Florida and Texas, have started offering shots to everyone over 65, leading to a chaotic scramble for vaccination appointments at pharmacies and hospitals.

It is in Britain, though, that a sense of urgency has driven the most radical change from established procedure. A more infectious variant of covid-19 which was first identified in September has led to an unprecedented increase in cases and driven a new vaccination strategy. Following the advice of experts on the country's Joint Committee on Vaccination and Immunisation (JCVI), the government's chief medical officers have advised it to prioritise delivering ▶▶

# WHAT IS AVAXHOME?



# AVAXHOME-

the biggest Internet portal,  
providing you various content:  
brand new books, trending movies,  
fresh magazines, hot games,  
recent software, latest music releases.

Unlimited satisfaction one low price

Cheap constant access to piping hot media

Protect your downloadings from Big brother

Safer, than torrent-trackers

18 years of seamless operation and our users' satisfaction

All languages

Brand new content

One site



**AVXLIVE** **ICU**

AvaxHome - Your End Place

We have everything for all of your needs. Just open <https://avxlive.icu>

► first doses of vaccine over providing the expected second doses to those who have already received one. Second doses will still be supplied, but later.

Second doses increase the level of protection offered by the first dose and should extend that protection's duration—both good for the person involved. Nevertheless, in the short term first doses on their own do more for the unvaccinated than second doses do for the vaccinated. So for every 1,000 people not given a second dose, and thus deprived of a marginal improvement in protection, 1,000 people can be given the substantial initial protection offered by a first dose alone. Half as much vaccination for twice as many people should slow both the rate of new cases and the spread of the disease.

On the question of whether delaying the second dose puts long-term protection at risk, the JCVI points to evidence from the trials of the AstraZeneca-Oxford vaccine that longer gaps do not do any such harm, and may even improve protection. There is no information of this kind for the Pfizer-BioNTech vaccine. On the question of how well the initial protection lasts if it is not boosted, though, there is little evidence to go on. In the trials, almost everyone who got a first dose got a second dose after three to four weeks.

The British government plans to vaccinate all of its four top-priority groups—care-home staff and residents, front-line health- and social-care workers, everyone over 70 and those with conditions that make them highly vulnerable—with a first dose by mid-February. Second doses may then take as long as three months.

Most of the criticism of this move has come from overseas, which may reflect a wariness by British scientists to cut across the government's public-health messaging

### Surplus and deficit

Covid-19 vaccine coverage

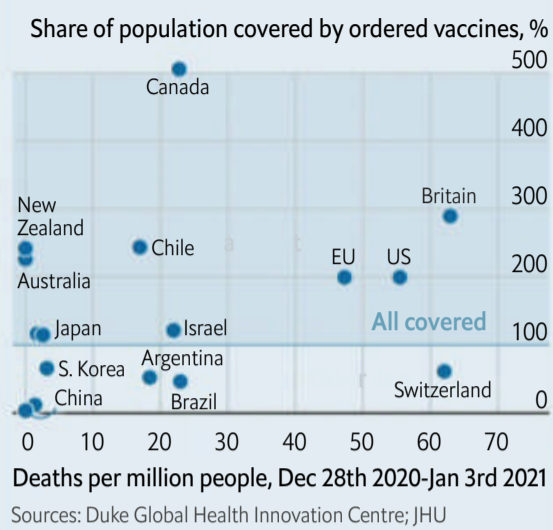

at a crucial time. There is a valid concern that patients will have much more certainty about the protection they will receive if they are vaccinated in exactly the same manner that trial participants were. And many patients consented to their first dose on the expectation they would get a second shot. Another worry is that the presence of a fairly large population of only-partially immune patients might encourage the development of viral strains that can get around the sort of protection that the different vaccines offer.

### A last hurrah

That has to be measured against the fact that, before any of the trial data were in, the lowest acceptable efficacy for candidate vaccines was put at just 50%. First dose efficacy—which the JCVI puts at 90% for the Pfizer-BioNTech vaccine, 70% for the AstraZeneca-Oxford one—would have to drop off fairly steeply to offer lower protection than that.

The outcome will be watched carefully. In various places, including Germany and Quebec, there are discussions of doing something similar. If it works, it will speed up the protection offered to whole populations. If it does not work, though, it may risk damaging confidence in vaccination well beyond Britain—damage that the world can ill afford.

In France, where anti-vaccine feeling has long been strong, only 40% of the population tell pollsters they are willing to be vaccinated (hence the high level of concern over consent). In Brazil, where vaccination has generally been popular, the number of people saying that they do not wish to be vaccinated has reached 22%, up from 9% in August; 50% do not want to be vaccinated with the Chinese vaccine on to which Mr Bolsonaro has poured scorn.

In America, a national survey conducted in December found that 29% of people working in health-care settings were hesitant about taking a covid vaccine. “For the most part we are seeing good uptake with health-care workers”, says Ms Hannan. But there are pockets of resistance. In Ohio, anecdotal evidence suggests that more than half of workers in nursing homes have turned down the jabs; in some counties in California 40-50% of front-line workers have said no. Rates of refusal are particularly high among black and Latino workers.

It is this background of distrust which makes it so important to get vaccination roll-outs, and the public-information campaigns around them, right. Mistakes—such as, in the worst case, the use of a batch of vaccines that proves harmful, or the discovery of a side-effect to a vaccine that regulators missed—could derail efforts in many countries.

But if there are risks of fear and distrust spreading quickly from country to country, a connected world also offers benefits when it comes to fighting a pandemic. The high level of support for COVAX shows that rich nations have a new willingness to help ensure that high-risk populations across the world have access to vaccination. It seems likely that Joe Biden's administration will sign up to COVAX—Donald Trump's had no interest in such things—improving the situation further. If America comes to see value in competing with Russia and China for the soft power bestowed by providing vaccines beyond its borders that will be all to the good.

This is the first global-health emergency in which new treatments are being rolled out to poor countries at about the same time as in richer ones. That process will undoubtedly be fraught with inequity. It is still worth celebrating. It is not, perhaps, as profound a break with the past as the ability to develop a quiver full of brand new jabs in less than a year. But it is impressive, and heartening. ■



A prick is not a pleasant prospect to everyone



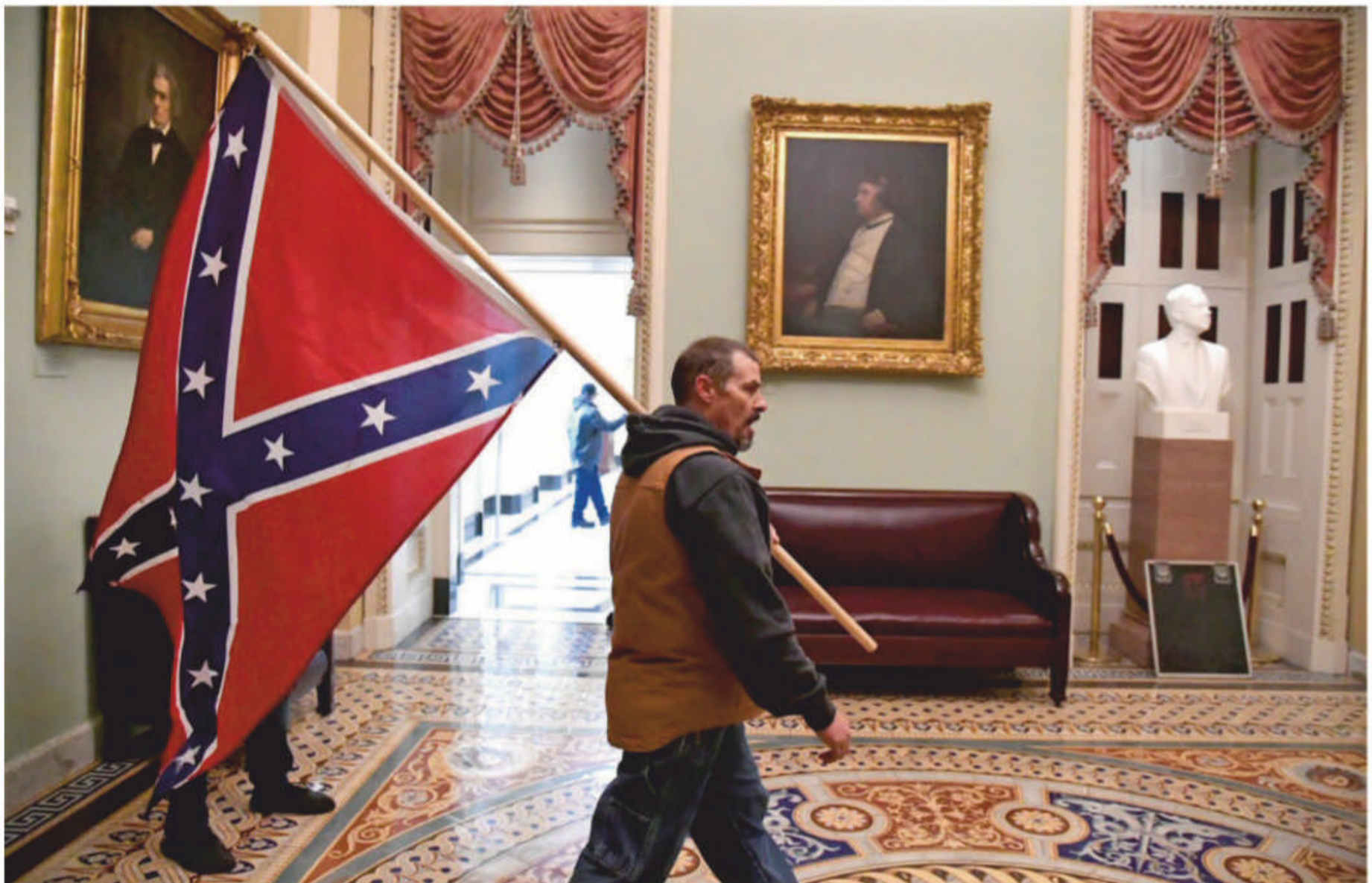

### The Republican Party

## After the insurrection

WASHINGTON, DC

**The terrible scenes on Capitol Hill illustrate how Donald Trump has changed his party; and how hard it will be to rid it of him**

THE MOST important book of the Trump era was not Bob Woodward's "Fear" or Michael Wolff's "Fire and Fury" or any of the other bestselling exposes of the White House circus. Arguably it was a wonkish tome by two Harvard political scientists, Steven Levitsky and Daniel Ziblatt, published a year into Donald Trump's presidency and entitled "How Democracies Die".

After many years researching democratic slippage in Eastern Europe and Latin America, the duo admitted to experiencing double-take as they turned to their own country: "We feel dread...even as we try to reassure ourselves that things can't really be that bad here." An invasion of the Capitol Building on January 6th by thousands of Mr Trump's supporters brandishing baseball bats and Confederate battle flags suggested they really are.

Summoned to Washington, DC, by the defeated president to protest against a congressional vote to approve the results of the

electoral college, they occupied the building for over four hours, sent Vice-President Mike Pence and other lawmakers fleeing for safety and vandalised the office of the Speaker of the House of Representatives. Four people died during the rampage, including a woman shot by police. Journalists were manhandled and had their cameras smashed by MAGA thugs in camouflage gear. Mr Trump meanwhile tweeted out his "love" for the insurrectionists. "Very special people," he called them in a video recorded from the White House. His Twitter and Facebook accounts were both later suspended. Pipe-bombs were placed outside

---

→ **Also in this section**

**25 Georgia's run-off elections**

**26 American policy and the Uyghurs**

---

— **Lexington is away**

the nearby headquarters of the Republican and Democratic parties.

It might be argued that the Senate session that the insurrectionists interrupted was more troubling still. Over two-thirds of Republican members of the House of Representatives and over a quarter of Republican senators were on the verge of voting to magic Mr Trump's defeat into victory by rejecting the electoral college-votes of a handful of states that he lost.

Naturally, in a familiar refrain of the *golpista*, the congressmen concerned claimed to be trying to protect democracy, not overthrow it. Josh Hawley of Missouri, who led the Senate effort, declared that "millions of voters concerns about election integrity deserve to be heard". A 41-year-old graduate of Stanford University and Yale Law, who has rebranded himself a scourge of the elite under Mr Trump, Mr Hawley was photographed raising a fist of defiance to the MAGA mob shortly before it broke through the barricades.

The large majority of Republican voters who claim to believe that Mr Trump won re-election in November are not responding to rational concerns. If they were, they must have been reassured by the unprecedented number of court rulings, safety-checks and recounts that Mr Trump's two-month effort to overturn the results has given rise to. His legal team's 60-odd chal- ▶▶



► lenges were laughed out of court; including the US Supreme Court. His administration's election security team adjudged the poll "the most secure in American history". The justice department and its Trump-loyal former boss, Bill Barr, concluded there had been no significant fraud. Yet the belief that Mr Trump was robbed has hardened among the Republican electorate. A poll for *The Economist* by YouGov this week suggested 64% wanted Congress to overturn the election result for Mr Trump.

To illustrate the depths of that deception, consider the sentiment among Republicans in Wisconsin, a state Mr Biden won by 20,608 votes. The president's lawyers have filed six failed legal challenges to the result, including in the US Supreme Court. They also instigated a recount in Wisconsin's most populous counties, Milwaukee and Dane, adding 87 votes to Mr Biden's tally. Wisconsin's Republican senator, Ron Johnson, held a Senate committee inquiry into Mr Trump's allegations; he subsequently told *The Economist* that he saw no reason to question the results in his home state. Yet Terry Dittrich, chairman of the Waukesha County Republican Party, Wisconsin's biggest, maintains that Mr Trump won it, in an election riddled with fraud, and he claims to know no Republican who thinks otherwise.

For evidence the 59-year-old real-estate professional offered a list of concerns about the vote that Wisconsin's conservative chief justice dismissed—including a big increase in postal voting that Mr Dittrich considered "absolutely fraudulent". He also raised the simple fact that Mr Biden performed creditably in leafy Waukesha County, on the outskirts of Milwaukee, just as the Democrat in fact did in affluent white suburbs across the country. "There is absolutely no way Biden outperformed Barack Obama in Waukesha County by the numbers they are proclaiming," Mr Dittrich said. "We're not giving up on this. It's not about being a bunch of Cry Babies or sore losers. We are law-abiding citizens who just want a clean election."

William F. Buckley junior, one of the architects of the modern conservative movement, called conservatism "the politics of reality". To the contrary, it now seems. A majority of Republican voters have in effect accepted Mr Trump's claim that Democrats cannot win legitimately and that a lack of proof of their machinations is proof of a cover-up.

"It is difficult to conceive of a more anti-democratic and anti-conservative act," was the generally-reticent Paul Ryan's verdict on the decision of so many Republican congressmen to support that fiction. The final congressional vote, held after the insurgents had been cleared from the Capitol Building and its hallways swept for explosives, certified the electoral college results,

with objections from 130 Republican House members and half a dozen senators. For his part, Mr Ziblatt said he viewed this stunt as a "dress rehearsal" for the more serious Republican effort to overthrow an election he now considers probable.

There are reasons to hope that will turn out to be too pessimistic. The Republicans who voted to overturn the results did so recklessly and cynically, but in the knowledge that they would not succeed. Those Republican officials who actually could have changed the election's outcome mostly hewed to the constitution. They included Georgia's secretary-of-state, Brad Raffensperger, the subject of a campaign of intimidation and abuse by the president and his cronies. This week Mr Raffensperger released a recording of the president inveigling him to "find 11,780 votes", shortly before Georgia's two Senate run-off elections were held on January 5th. Mr Trump's additional attacks on Mr Raffensperger and other principled Georgian officials appear to have done his party no favours. The Democratic candidates, Raphael Warnock and Jon Ossoff, won both races, giving their party its first Senate seats in the state for 20 years, control of the Senate and a unified government.

The following day, Mitch McConnell, thus denuded of his Senate majority, issued a stinging denunciation of Mr Hawley and the rest. Overthrowing the electoral college votes "would damage our republic forever," said Mr McConnell, who is rarely accused of acting on principle. Minutes later Mr Trump's special people launched their invasion of the Capitol—which in turn emboldened senior Republicans to criticise the president more directly than they have previously dared to.

Senator Tom Cotton of Arkansas, an erstwhile defender of Mr Trump said it was

"past time" he "quit misleading the American people". Liz Cheney, the third-ranking House Republican, said there was "no question" Mr Trump had "incited the mob". Even a few hardcore Trumpkins joined the chorus. A remarkable statement put out by the erstwhile pro-Trump National Association of Manufacturers called on Mr Pence to consider invoking the 25th-Amendment to remove the president from office.

This is still some way short of a wholesale repudiation of Mr Trump by the Republican establishment. And without that, it is hard to imagine him relinquishing his grip on the party, affording it an opportunity to recommit itself to democratic norms. Yet that repudiation is now more imaginable. The president's cheerleaders in the conservative media, all law-and-order obsessives, may find it hard to dismiss images of the Capitol Building overrun by MAGA thugs. They might even struggle to blame them on the Democratic left (though some have tried). Middle America, however polarised, dislikes mob violence and cherishes the symbols of its democracy. One commentator recalled the shift in public support from the Republicans in 1995, after Timothy McVeigh, a member of the sort of freedom-loving militia previously championed on the right, blew up a federal building in Oklahoma City, killing 168 people. The parallel is inexact, but points to how far Mr Trump and his MAGA shocktroops appear to have overstepped.

Even before this week's events, the firm view of most senior Republicans that Mr Trump would retain his lock on the party seemed too strong—a case of Stockholm syndrome, perhaps. "The base thinks Trump is a martyr," said one Republican senator, "For the next two years, maybe four, he'll be able to screw you in a primary without lifting a finger." That might turn ►►



This American carnage



► out to be right. Yet voters want a winner, which is why Grover Cleveland, in 1892, is the only one-term president to have been re-nominated. And after Mr Trump leaves office, and fades from daily view, more and more Republicans may start to recognise what the stolen-election myth is designed to conceal: his electoral weakness.

The myth's proponents cite the many new voters he attracted in November to explain why Mr Trump could not have lost. Yet that rests on wishing away (as Mr Dittrich does) the fact that Mr Biden turned out many more. In an election that saw record-breaking turnout for both main parties, the Democrat won the 6m voters who had previously voted for a third-party candidate by a ratio of 2:1. He won first-time voters at the same rate.

Mr Trump also ran behind most Republican congressional candidates. His party made a net gain of ten in the House and almost kept its majority in the Senate, even as he lost the presidential race by a lot. That suggests the Republicans post-Trump future could be strong. Notwithstanding their losses this week in Georgia—a state whose young and diverse electorate has long been trending Democratic—the Republican brand has not been too damaged by the Trump years. The party also has a big advantage in the toxicity of the Democratic left, which its candidates talked up endlessly during the campaign, and which appears to have been especially effective in winning over Latinos. Carlos Curbelo, a former congressman from southern Florida, where new Latino supporters helped the party flip two House seats, describes that advance as “a huge development, the thing Republicans are most excited about.” He considers it a pointer to the party's ideal possible future—as a multi-ethnic coalition dedicated to providing market-orientated solutions to big problems, such as climate change, that left-wingers would throw the government at.

These are reasonable conjectures. They underline the fact that the party's future course is not set. No one predicted Mr Trump back in 2012. And the disruptive effect of his disregard for conservative verities has probably increased the ideological possibilities on the right. Most of his 16 primary opponents in 2016 spouted similar Reaganite bromides. An equivalent contest today might showcase the pragmatic conservatism of Governor Larry Hogan of Maryland, the feverish Sinophobia of Mr Cotton, and the big-government populism of Senator Marco Rubio, all of which have to some degree been shaped or promoted in response to Mr Trump. Yet this happier post-Trump future for the president's party is so far only a theoretical possibility.

The reality of Trump populism is not heterodox conservative thinking—which has yielded few policies worth mentioning



**The orderly and peaceful transfer of power**

in the past four years—but the grassroots furies unleashed on Capitol Hill this week. And quelling them will not be easy even if Mr Trump goes. Indeed they predate him.

Grass-roots populist movements have emerged on the right every couple of decades, for different reasons, but with a characteristic commitment to purging the conservative establishment, and a tendency towards conspiracy theories and paranoia. Joseph McCarthy's Red Scare in the 1950s was succeeded by Barry Goldwater's movement in the 1960s, the more presentable Reaganites in the 1970s and the Gingrichites in the 1990s. The usual pattern, notes Geoffrey Kabaservice, a political historian, was for the insurgents to arise, win power and knuckle down to governing; whereupon they become the new establishment, and so in turn are challenged and displaced. Yet over the past decade, as economic insecurity has intersected with political polarisation and accelerating cultural and demographic change, the insurgent waves on the right have become more frequent and more radical.

The Tea Party that erupted in 2010, in response to a tough economy and Barack Obama, sent 87 radical conservatives to Congress. But there they showed no interest in knuckling down. They propagated the racist “birtherism” conspiracy against Mr Obama. They attacked bipartisanship, governing generally, and their party leaders (driving out the former Gingrichite House Speaker, John Boehner). The 2013 government shutdown and campaign to “repeal and replace” Obamacare with thin air were their signatures. Instead of being displaced, they morphed into the MAGA crowd. Which has since propagated more radical versions of itself, such the Trump ultras of QAnon, a movement committed to sniffing out socialist paedophile rings in

Washington. “Conservatism's familiar pattern of advance, consolidation, retrenchment and renewal has vanished,” writes Mr Kabaservice. “In its place is something that looks like #MAGA Forever.”

This development can also be seen up close in Wisconsin, where the Tea Party wave helped bring to power, under Scott Walker, what at first looked like a bold new experiment in conservative governing. Yet the state's Republican base, whipped up by the conservative media, tuned out to be less moved by Mr Walker's school voucher system than a racially-infused hostility to the other side. In a purple state, formerly known for bipartisan comity, an extreme Republican gerrymander in 2011 gave the party a supermajority in the state legislature. This liberated Wisconsin Republicans from having to appeal to swing voters, the usual force for moderation. They passed voter-identification measures which depressed non-white turnout in diverse Milwaukee, helping Mr Trump win the state in 2016. When Mr Walker and the state's attorney-general lost elections in 2018, the legislature passed laws to strip away the powers of their offices before their Democratic replacements could take over. This was a case-study in Republicans' abandonment of two norms Messrs Levitsky and Ziblatt consider essential to a secure democracy: forbearance and mutual respect.

The Republican base was meanwhile growing more radical. The Waukesha Republicans, once a bastion of well-heeled Reaganism, have been transformed by an influx of Trump super-fans. Many are working-class whites, with no prior attachment to the party, who consider Mr Trump to be at war with the corrupt Washington establishment. Mr Dittrich says such voters now account for 70% of his membership. “They are OK with being called a Re-►



publican because they support President Trump," he says. "But if they feel the party is not supporting President Trump then they are not likely to be as loyal as Republicans were in the past." In September the mother of Kyle Rittenhouse—a 17-year-old vigilante who had been charged with killing two people at a Black Lives Matter Protest in Kenosha, Wisconsin, the previous month—attended a dinner of a sister organisation, the Republican Women of Waukesha County. She was given a standing ovation.

This illustrates why Republican voters could indeed stay unusually loyal to their defeated leader—and how hard it will be to wean them back to moderation even if they do not. They are a new base, dominated by white, working-class males, who hear the president's raging against the liberal and conservative establishments as an expression of their own frustrations in a changing country. They make the Tea Party look constructive. Mr Trump has ushered into the conservative mainstream a politics of emotion and mindless opposition, as far from the governing philosophy of Reaganism as it is from communism. "If Reagan was around today it would be very hard to convince the Republican Party that he was a staunch conservative," concedes Mr Dittich, of his former hero. For his part, the genial party chairman claims to have "moved a little bit more conservative", a development he finds hard to explain, though he contrasts it with his former enthusiasm for bipartisanship.

It is fairly hard to imagine the right reverting from this frenzied state to the moderate Reaganism of Mr Hogan, Maryland's governor. Mr Rubio's idea, which is essentially to keep working-class voters on

board with populist economic policies, while dialling down the cultural messaging sufficiently to woo back some suburbanites, may be more promising. It is not clear that this more serious populism's industrial and other policies differ much from those of the centre-left, stripped of their environmental concerns. It has also generated almost no enthusiasm among the party's pro-business establishment. But it has a compelling political logic. It should also be clear that almost any course that can move the Republican Party back to governing, from cultural grievance and resistance, should be welcomed.

Mr McConnell and his Republican caucus should view the looming possibility of co-operation with the Biden administration as an opportunity to that end. The president-elect is a veteran Senate dealmaker, keen to govern from the centre. And the slimness of the Democrats' Senate majority will give his party no other option but to try to. The conventional wisdom is that Mr McConnell, an old hand at disloyal opposition, will want no part in that—just as he obstructed the Obama administration. But, in retrospect, he might consider that that didn't work out so well for his party.

It pushed Mr Obama to the left, and helped fuel the growing partisan rage on the right. That in turn helped lead to the Tea Party, to Mr Trump and to this week's disgraceful anti-democratic lurch among Senate Republicans—that Mr McConnell, to his credit, stood firmly against. Surely he and his Trump-bruised Republican colleagues don't want to go through that again. Working with Mr Biden, to fix some of the country's most aggravating problems, would be a sign that they do not. ■

## Georgia's run-off elections

# So sweet and clear

ATLANTA

## Two stunning victories for Democrats in Georgia upend the Senate

FOUR YEARS ago, any pundit predicting that the solidly Republican state of Georgia would send two Democratic senators to Washington in 2020 would have been dismissed as a crank. Yet that was the outcome of two extraordinary run-off elections held on January 5th, which may set a new model for winning Democratic campaigns in the usually inhospitable South. The contests were also the costliest Senate races ever—more than \$500m was spent on a deluge of advertising alone—because they will determine control of the Senate for the next two years.

Raphael Warnock, the first African-American ever to be elected to the Senate from the South, defeated Kelly Loeffler, the Republican incumbent. The other Democrat, Jon Ossoff, defeated Senator David Perdue, meaning the Senate will be tied at 50-50, giving the vice-president-elect, Kamala Harris, the casting vote in the upper chamber. Democrats will thus have secured the Washington trifecta of House, Senate and White House needed to pass legislation. For the incoming president, Joe Biden, this means a chance to convert at least some of his ambitious agenda from a pile of white papers into reality. For the outgoing president, Donald Trump, it is a startling rebuke.

Though the elections' national ramifications may take most headlines, the contests also reflect Georgia's idiosyncrasies. The state is unique in requiring a head-to-head run-off if no candidate commands a majority in the general election. On November 3rd Mr Perdue secured a greater share of votes than did Mr Trump, who lost the state by a razor-thin margin. The president has since been consumed with attempts to overturn that result through recounts, lawsuits and, most disturbingly, direct pressure on Georgia's top elections officer to "find" the necessary votes to steal the election.

Run-offs typically favour Republicans: they tend to be snoozy events that attract only the most committed voters (older, whiter and typically more conservative). That did not happen this time. Turnout was estimated to be 4.5m, or 89% of the record-setting tally in November. It was high enough in the right places to suggest a Democratic finish ahead of Mr Biden's.

Despite its long spell in Republican hands, Georgia has become more competitive because of two demographic trends—a



The establishment protected itself



### Peaches and cream

Georgia, counties where Democrat votes increased from the presidential election 2020 to the Senate run-off 2021\*

Percentage point increase 0 1 2 3 Decrease

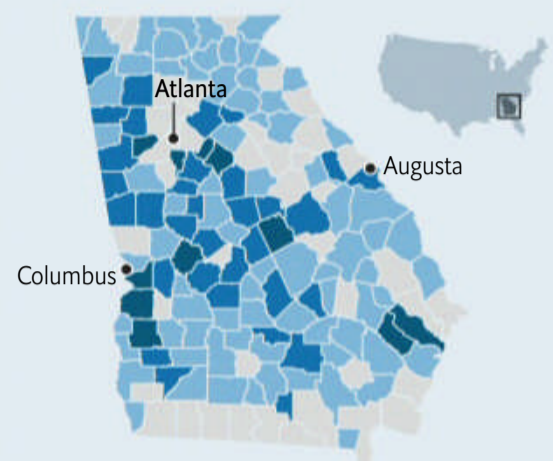

\*Raphael Warnock's margin minus Joe Biden's margin  
Sources: Georgia Secretary of State; AP

► substantial increase in registered non-white voters, who tend to be reliable Democrats if they can be convinced to turn up to the polls, and a shift among educated, suburban whites away from the Republican Party. Both have been driven, among other things, by the economic growth in and around Atlanta.

During the presidential election, Mr Biden's narrow victory was probably based more on a white revolt in the suburbs than on a dramatic surge in the black vote. Despite large increases in registration of black voters, after years of effort by grassroots groups, the black share of the electorate actually dropped between 2016 and 2020. Without defections among whites in Atlanta's suburbs, Mr Biden might not have won Georgia's 16 electoral-college votes. The story of the run-off, in contrast, seems to have been higher turnout among black voters, who made up a larger share of the early vote, and mostly voted Democrat.

Nse Ufot, the CEO of the New Georgia Project, which seeks to increase turnout among young and non-white voters, credits an organising feat that was years in the making. The group says it has knocked on 2m doors, dispatched 3m text messages and dialled phones 5m times. Ms Ufot notes that there were 120,000 early voters who skipped the presidential election altogether. It may also have helped that neither of the two Democrats was the party's standard Southern candidate: a milquetoast, carefully calibrated, mildly conservative fellow in soft-bellied middle-age. Mr Warnock is a pastor who preaches in the same church that Martin Luther King Jr once did. Mr Ossoff is a 33-year-old Jewish documentary film-maker. Neither has a genteel twang: Mr Warnock's cadences are those of a practised sermoniser; Mr Ossoff's those of a Barack Obama impersonator.

Whether the disappointment of the

run-offs will prompt a wider Republican break from Mr Trump is unclear. Many thought that defeat in November would break his ironclad hold over the party. Not at all. Both of the incumbent Republican senators in the run-off called for the resignation of the Republican secretary of state who oversees the election for failing to endorse Mr Trump's view of the world (which is that it is impossible for him to lose an election without unspecified masses of fraud occurring). They also expressed support for Republicans refusing to certify the results of the presidential election.

Mr Trump's antics left both Republican senators in an impossible position—reliant on the flailing, departing president for his devoted voters, and unwilling and unable to cross him even as he descended into dark, anti-democratic fantasies. This tied Republican voters, most of whom say they believe the president's theories about voter fraud, in chains of illogic. Why turn out to vote in a state that Mr Trump says was hopelessly crippled by fraud just two months ago? If the state's Republican governor and secretary of state could not be trusted to safeguard the last election, why bother with this one? Why was the battle cry of the Republicans' Senate run-off campaign to keep socialism at bay if Mr Trump (not Mr Biden) was to be president? Whether Mr Trump so demotivated Republican voters as to have sabotaged an expected victory for his party is hard to know in a race that is so close.

For Mr Biden, however, the prize is immense. "Georgia, the whole nation is looking at you," he told a drive-in rally in Atlanta on the eve of the poll. "One state can chart the course not just for the next four



President with reverend

years, but for the next generation," he went on. With the Senate in effect under Democratic control, Mr Biden will have a much easier and speedier time in getting his nominations for the cabinet and federal courts confirmed. He will not have the filibuster-proof majority required to pass the sort of agenda that he campaigned on. But the Senate will pick up legislation passed by the Democratically-controlled House. Conservative Democratic senators like Joe Manchin of West Virginia and Kyrsten Sinema of Arizona will wield disproportionate power. But to the new White House they will be much more welcome negotiating partners than Mr McConnell. The stakes in Georgia were always much larger than one state. ■

### American policy and the Uyghurs

## Working on the chain gang

NEW YORK

**Congress is moving to block goods made with the forced labour of Uyghurs**

IF A SPORTSWEAR company like Nike or Adidas wants to know if any of the fabric in their socks or trainers is from Xinjiang, supplier of 20% of the world's cotton, forensic science can help. Oritain, a firm based in New Zealand, says it can analyse sample swatches of cotton to determine whether particular elements—including zinc, potassium and rare-earth metals like cerium—are present in the same proportions as in cotton grown from the soil of the north-west region of China. Such tests of provenance are becoming valuable, because evidence is mounting that textiles made with cotton from Xinjiang, and other

goods with links to the region, are the fruit of the forced labour of Uyghurs. The Trump administration has already moved to stop some imports from Xinjiang into the American market, and in the coming months Congress is expected to give customs officials greater power to do so. Other countries may follow America's example.

In the past four years China's ruling Communist Party has overseen the internment of more than 1m Uyghurs, a predominantly Muslim ethnic group that is indigenous to Xinjiang, in mass detention centres. In December the BBC and the Centre for Global Policy in Washington report- ►►



► ed that at least a half-million Uyghurs were being put to work in cotton fields, conscripted to do a job handled by machines in many parts of the world, under the auspices of “poverty alleviation”. On December 28th BuzzFeed News reported, with the help of satellite imagery, the construction in the past few years of 21m square feet (nearly 2m square metres) of factory facilities on the grounds of more than 100 detention centres in Xinjiang.

The revelations have done little to slow the flow of goods from Xinjiang. In 2019 exports from the province totalled \$17.6bn, about the same as in 2017 (\$17.5bn), including more than \$300m in goods that went to the American market in each of those years. Goods manufactured elsewhere carry some trace of Xinjiang in their supply chain: in addition to cotton in textiles, for example, Xinjiang’s tomatoes account for a significant fraction of the world’s ketchup, and its rare-earth metals are used in technology products. Until last year, governments and industry leaders around the world said little to directly challenge China over allegations of forced labour. But that has begun to change.

America is taking the lead. In March a bipartisan group of members of Congress introduced the Uyghur Forced Labour Prevention Act, which would establish a presumption that all goods from Xinjiang are made with forced labour, blocking them at the border unless companies can prove otherwise. In July the Trump administration issued an advisory to American businesses about the risks of Uyghur forced labour in their supply chains.

Since June American customs officials have issued a series of orders blocking certain shipments from Xinjiang, including, in December, any imports of cotton products that can be linked to the Xinjiang Production and Construction Corps, known as the *bingtuan*, a powerful state-owned paramilitary organisation that is responsible for a large share of cotton-growing, ketchup-making and manufacturing in the region. (The Trump administration also imposed financial sanctions in July on the *bingtuan* and high-ranking party officials implicated in the atrocities in Xinjiang.)

Businesses are starting to take note. On December 23rd the Fair Labour Association, a consortium that counts Nike and Adidas among its affiliate members, declared that it was “prohibiting sourcing and production” from Xinjiang, including raw materials like cotton that might end up in finished goods elsewhere. The organisation said it had never before issued such an edict in its 20-year history, but that the human-rights and labour violations in Xinjiang were uniquely challenging.

Not all businesses appear ready to decouple from Xinjiang entirely, or at least quickly. The legislation in Congress has

been the subject of intense lobbying from industry, including representatives of big clothing-makers, who have sought, among other changes, a delay of up to one year in enforcement. Representatives of apparel firms say it will take time for all of them to shift supply chains, and to encourage more cotton-growing elsewhere. They are getting more time as it is. The House of Representatives passed the bill in September; but it failed to get through the Senate before adjournment, and will have to be reintroduced in the new Congress.

### Them ole cotton fields

Industry representatives insist that their members are serious about the problem. They expect Congress to pass the forced-labour bill. And they expect the incoming Biden administration to continue the Trump administration’s enforcement actions against Xinjiang imports. But they argue that it is difficult to penetrate deep into their supply chains to verify the origin of raw materials—for example, yarn knitted from cotton from different parts of the world. In September, testifying before Congress, Stephen Lamar, head of the American Apparel and Footwear Association, said there was not yet reliable technology to link cotton to Xinjiang with “reasonable” confidence. Oritain, the New Zealand firm, disputes that, saying that when it traces a swatch of cotton to the soil of Xinjiang, it does so with 95% confidence. The company can also confirm a brand’s contention that its cotton is from America. (Mr Lamar contends that under the anticipated legislation, 95% confidence would not be enough, and that without “foolproof accuracy”, products will be detained.)

Experts (as well as industry groups) argue that the efforts of Congress and the Trump administration will have a limited impact unless other governments follow suit. A shirt that cannot be shipped to America can go to Australia, Canada or France instead. In the European Union the issue of Uyghur forced labour hangs over an investment deal that has been negotiated with China (see Europe section). In December a bill similar to America’s was introduced in Australia’s parliament. Leading clothes-makers in America and Europe have responded to the Trump administration’s actions and the proposed legislation—and to the stream of damning published reports about forced labour—by moving with more urgency to shift production away from China, if often quietly so (a few have made strong public statements).

But the largest market for Xinjiang cotton—the rest of China—will be unmoved. Amy Lehr of the Centre for Strategic and International Studies, which has produced reports on China’s pressing of Uyghurs into forced labour, notes that 88% of China’s textiles and clothing are produced for domestic consumption. Large non-Chinese firms are among those who profit. One executive whose firm audits supply chains says that a potential client told him, “Look I don’t care if there’s Xinjiang cotton. We’re just going to use that for the Chinese market.” American laws, aided by forensic science, will help to combat forced labour in Xinjiang. But more countries and multinational companies will also have to forgo their immediate self-interest and take on China directly. As Ms Lehr says, “This is too big a problem for even the United States to address on its own.” ■



Do you want ketchup with that?





### Abortion in Latin America

## Green wave, blue breakwater

MEXICO CITY

**Legalisation in Argentina will invigorate pro-abortion activists—and their foes**

WITHIN DAYS Argentina's president, Alberto Fernández, is expected to sign a law making abortion legal. Argentine women will be able to terminate their pregnancies within the first 14 weeks for any reason. The measure is a big deal. With 45m people, Argentina is the fourth-most-populous country in Latin America, a predominantly Catholic region, and the native country of the current pope. It is now the largest of the few Latin American countries that allow abortion on demand (see map on next page). Argentina's new law will see the share of women in the region with such access rise from 3% to 10%.

Pro-abortion groups hail it as part of a *marea verde* (green wave), named for the verdant scarves worn by women's-rights campaigners, not all of whom advocate greater access to abortion. Argentina's decision has inspired discussion in Peru, says Susana Chávez, an obstetrician and congressional candidate for the centrist Purple Party. There is "an opening, and parties and politicians are starting to talk about it", she

says. Mexico's left-wing president, Andrés Manuel López Obrador, who has tried to avoid the issue, seemed to grant the possibility of liberalisation after Argentina's decision. Women should decide whether the law should be changed, he said.

But Argentina's decision will also invigorate abortion's foes, many of whom are women. "It sets up a battlefield," says José Miguel Vivanco of Human Rights Watch (HRW), a pressure group. Anti-abortion activists in Argentina, who have adopted sky blue as their colour, say the new law is unconstitutional. As the health ministry rushes to deliver misoprostol, a medication that can terminate pregnancy, to the country's provinces, abortion's foes are preparing challenges in the courts.

By global standards, abortion laws in

---

→ **Also in this section**

**29 Barbados's covid-19 spike**

— **Bello is away**

---

Latin America and the Caribbean are unusually restrictive. Cuba, Guyana and Uruguay allow abortions on demand within the first trimester. (In Britain they are elective until 24 weeks.) Belize allows terminations on social or economic grounds. Most other countries allow a woman to end her pregnancy in narrow circumstances. Some in Central America, including El Salvador and Nicaragua, impose an absolute ban, with harsh penalties for women and doctors who breach it. The region has been less conservative on other social issues. Many countries that ban most abortions allow same-sex civil unions. Bolivia, which has a restrictive abortion law, had its first gay union in December.

Before Argentina's leap, other countries had taken small steps towards liberalisation. In 2017 Chile passed a law allowing a woman to terminate a pregnancy if it endangers her life, or she has been raped, or if the fetus has a fatal impairment. A number of Latin American countries, including Colombia since 2006, have similar provisions. In 2019 the Mexican state of Oaxaca became the second federal entity, after Mexico City, to allow elective abortion in the first 12 weeks of pregnancy.

Politicians and courts in several other countries are considering looser restrictions. Peru's Purple Party says it will promote "reproductive rights" if it wins the presidency in elections to be held in April. The issue may come up this year in ►►

▶ Chile when it drafts a new constitution. The current one “protects the life of the unborn” (as does Guatemala’s). In September Causa Justa, an NGO, filed a lawsuit that seeks to change Colombia’s penal code to decriminalise abortion.

Still, failures to liberalise, both through parliaments and the courts, are as numerous as successes. Criticism of Argentina’s law has been widespread. Paraguay’s Congress marked it with a minute’s silence. Brazil’s far-right president, Jair Bolsonaro, said that under his government “abortion would never be approved in our land”. Such backlashes are common. After Mexico City legalised abortion in 2007, 20 Mexican states tightened restrictions.

### Reproductive resistance

The Catholic church, which teaches that life begins at conception, remains powerful in Latin America. In places where it has weakened, evangelicals have taken up the cause with equal zeal, if less institutional clout. Under the Trump administration the United States has backed resisters. It ended or reduced funding of organisations that provide abortions or advocate liberal laws. Last year it reduced financing for the Organisation of American States for supporting easier access to abortion. Although a large share of politicians are women, including more than half of MPs in Cuba and Bolivia, many do not press for greater access to abortion. Some rights groups that are vocal about issues such as femicide do not campaign to make abortion legal.

Most Latin Americans are still conservative on the issue. A recent poll found that only 35% of Argentines and 16% of Peruvians thought women should be allowed to terminate early pregnancies without restrictions, compared with more than 60% in several western European countries. In cases where a woman has been a victim of rape, support for abortion rises to 72% in Argentina and 49% in Peru.

Bans do not prevent abortion. Worldwide, in any year, 39 women out of 1,000 aged 15-49 have abortions. In Latin America the rate is slightly lower, at 32. But in the United States, Canada and Europe, where rules are more permissive, the rate averages just 17.

What bans do, point out campaigners for liberalisation, is make abortion unsafe and lead to harsh penalties, including prison sentences, for women and medical professionals. In Venezuela maternal mortality rose by 66% between 2015 and 2016, according to its health ministry. A rise in the number of abortions, which are thought to cause a fifth of maternal deaths in the country, contributed to the increase. Women who miscarry or have stillborn children can be accused of having had an abortion. In Colombia denunciations by hospital staff initiated 73% of abortion in-

vestigations between 1998 and 2019, according to the country’s attorney-general. These breach patient confidentiality.

In Nicaragua Silvia (not her real name) began bleeding profusely after taking misoprostol to end a pregnancy a few years ago. She went to hospital, but after two nurses examined her and told her to wait for a doctor to perform an ultrasound she fled for fear of being handed over to the police. Such cases are not uncommon.

Simply making abortion legal does not make it available. In Argentina rural women and poor city-dwellers who were entitled to an abortion under the country’s old law could rarely get one, according to a recent report by HRW. In Costa Rica the exceptions to the country’s ban were so vague that many doctors refused to perform abortions. The president, Carlos Alvarado, published a 13-page clarification last year to provide “legal certainty”. Last August in Brazil a hospital refused a legal abortion to a ten-year-old girl who had been raped by her uncle. She had to be smuggled through the back door of a hospital 1,400km (900 miles) away in another state, which performed the procedure. Anti-abortion protesters had gathered there after her name was leaked on social media.

Prosperous women in Latin America, which has the world’s highest level of income inequality, rarely have such troubles. A popular saying holds that “*las ricas abortan, las pobres mueren*”—rich women abort, poor women die. Those who wear green scarves hope that Argentina’s new law will at least lead to fewer women dying. ■



### Bother in Barbados

## Rum punch and the pandemic

LITTLE GOOD HARBOUR

**An island with few covid-19 cases let its guard down, with disastrous results**

BARBACUDA, BLUE MARLIN and red snapper were for sale before Christmas at Millie Ifill fish market, but only to those who observed pandemic protocol: “No Mask No Service”, said a large sign. Local discipline and tests on travellers kept covid-19 cases in Barbados to a trickle. After a lockdown, bars and boutiques were doing brisk business. Reservations at restaurants such as the Fish Pot at Little Good Harbour were becoming hard to get. Locals said the island was in its own little bubble.

The bubble has burst. On December 31st the government scuppered “Old Year’s Night” fireworks parties. A curfew extends from 9pm to 5am, to contain a surge in infections. Nearby St Vincent has declared Barbados a “high-risk country”.

Two things went wrong. First, cracks appeared in the controls on travellers. Passengers to Barbados must test negative for covid-19 before flying and remain in quarantine until their second negative test. As holiday traffic picked up, so did the numbers testing positive after arrival.

A few have broken the rules. On December 29th Zara Holland, a former Miss Great Britain who was also a contestant on “Love Island”, a reality-TV dating show, and her partner, Elliot Love, allegedly removed the red warning bracelets put on them after Mr Love tested positive. They were apprehended trying to board a flight to London. Ms Holland has apologised “to the entire country of Barbados”. She has been sentenced to pay a fine of B\$12,000 (\$6,000).

Second, the virus has spread locally. On December 26th several prison guards took part in a “bus crawl”. These are advertised with raunchy names such as “brandy & punanny” (pussy), and involve open-sided buses and stops at bars and rum shops. The Boxing Day jolly seems to have been a super-spreader. At least 170 staff and inmates at Dodds Prison have contracted covid-19.

The opposition blames the government for failing to close the border to people from high-risk countries. Grenada and Jamaica stopped flights from Britain, because of its rampant new strain of the virus.

Barbados depends more on visitors from Britain than do most other islands. Its prime minister, Mia Mottley, has urged Barbadians to get “more serious”. Bus crawls are now banned. Tamper-proof bracelets are replacing cloth ones. Quarantine rules are tighter. Barbados has learned that bubbles and bus crawls don’t mix. ■





Private schools in India

## Permanently excluded

The schools that educate almost half of pupils are in dire straits

**F**IVE DOLLARS buys a month's education at Rafiq Siddiqui's private school, which serves the children of migrant workers living in a slum in Mumbai. But its corridors have been silent since March, when officials battling covid-19 closed schools across India. Mr Siddiqui, the principal, thinks almost 40% of his 900 pupils have left the city as their parents look for new jobs. The rest are "whiling away their time" at tea stalls and bus stops, seeking respite from the one-room dwellings many have to share with their families. Mr Siddiqui is trying to offer them online classes, but not many have easy access to smartphones. "We are going through a very long tunnel with no light at the end of it," he says.

India's education system was failing its children long before covid-19 forced them out of their classrooms. Only about 55% of the country's ten-year-olds can read and understand a simple story, reckons the World Bank. The last time India's children

participated in internationally comparable tests, they ranked almost last out of 74 countries. The most recent large survey of staff attendance, in 2010, found that almost a quarter of public-school teachers were absent. In the state of Jharkhand the figure was close to half.

Dismay at this state of affairs is one reason India's children have for years been flocking to private schools such as the one Mr Siddiqui runs. Before the pandemic nearly half of all children were privately educated, one of the highest rates in the world. Most are not from wealthy families. About 70% of fee-paying schools charge

less than 1,000 rupees (\$13) a month, according to the Central Square Foundation, a charity. Roughly 45% charge less than \$7.

These institutions are struggling as the school closure drags on. In October the government lifted a national prohibition on schooling in person, but local officials, who have the final say, have largely chosen to keep schools shut. Ekta Sodha, who runs a small chain of private schools in the state of Gujarat, says that, although her teachers are offering online learning, less than a tenth of parents are paying for it. Mr Siddiqui has kept only four of his 31 staff on the payroll. His school owns its own premises, but others in the neighbourhood are finding it difficult to pay rent, he says. A few have shut for good. More are on the brink.

The travails of private schools will make it even more difficult to remedy the damage prolonged school closures are doing to India's children. Studies suggest that, after controlling for class and wealth, children do not learn much more in private schools than they do in government ones. But private schools take on a huge share of the burden of education, vastly more efficiently. Some 80% of them charge fees that are lower than the cost per pupil in the public sector, according to Geeta Kingdon, an academic at University College London who also runs a private school in the state of Uttar Pradesh. The main reason is that teach- ▶

→ Also in this section

31 Hollow elections in Kazakhstan

32 Banyan: Kim Jong Un's wobble

33 Japan's growing Muslim population



► ers' salaries are set by the market, not by politics. Staff in public primary schools, in contrast, earn around eight times India's GDP per person. That is eight times more than the average in rich countries and well above the norm in neighbouring countries such as Bangladesh and Pakistan.

A large survey of rural schoolchildren carried out in September by Pratham, an NGO, detected a small shift in enrolment from private schools to government ones. It said this could be because parents who had lost their jobs could no longer afford the fees, or because the schools themselves had gone belly-up. If this trend accelerates the authorities will need to find a lot more cash for education, at a time when there is little to go around. The biggest worry is that some parents who can no longer send their children to a private school may prefer to keep them out of education altogether, rather than enroll them in a public institution with a bad reputation, or in a good one that is too far away. The exact scale of these shifts will be difficult to measure until schools are back in session.

Because private schools are required to operate as charities, they have not been allowed to take advantage of loan schemes to help small businesses. Rajesh Malhotra, the owner of a school in Delhi, says the local government has been a "mute spectator" of the problems he and others are facing. At the very least he wants the authorities to speed up payment of subsidies that private schools receive under rules that require them to admit a share of students from the very poorest backgrounds (the money sometimes arrives years late). He thinks that during the current crisis the government ought to produce the money in advance.

India cannot afford to give handouts to private schools, says Bikkrama Daulet Singh of the Central Square Foundation. But he hopes the crisis can change attitudes in government. Some states "ignore" private schools; others meddle unhelpfully, by tightly regulating fees, for instance. Slashing rules that make it difficult to set up and expand schools would help the industry recover more swiftly. Officials who are now required to check the size of playgrounds and the colour of walls could spend more time making sure the teaching in private schools is up to scratch.

The best thing would be to let schools reopen quickly, with some precautions. Vikas Jhunjhunwala, who runs two schools in Delhi, says many parents do not understand that their children are unlikely to fall ill even if they catch covid-19. India's extremely low rate of female employment makes families less reliant on schools for child care than they would be elsewhere. All this has made it easier for risk-averse state governments to keep schools shut, even though they have allowed many other

everyday activities to resume.

Such decisions do not take into account the full cost to children of keeping schools closed. In October the World Bank estimated that missing out on school for six months would reduce pupils' lifetime earnings by 5%, at a cost to the country of around \$450bn. Out-of-school children are more vulnerable to scourges that already plague India, such as child labour and forced marriage. Mr Siddiqui is keen to bring children back to class, using masks, social distancing and extra cleaning for safety: "We have to make a start." ■

### Parliamentary elections in Kazakhstan

## Five different ways to applaud

ALMATY

**All the parties on the ballot support the government**

WHEN KAZAKHSTAN'S president came to power two years ago, he made pronouncements that counted as radical in a country that had only just emerged from three decades under a single strongman. Painting himself as a cautious reformer, Kassym-Jomart Tokayev promised "political competition" in the oil-rich Central Asian state. That marked a change from his predecessor, Nursultan Nazarbayev, who won several elections with more than 90% of the vote and seldom faced any opposition from the rubber-stamp parliament. Yet the general election to be held on January 10th—the first since Mr Nazarbayev resigned in 2019—seems even less democratic than the six previous contests since Kazakhstan became independent in 1991. For the first time, no genuine opposition parties will appear on the ballot.

The ruling Nur Otan party will win in the usual crushing landslide. Led by the 80-year-old Mr Nazarbayev, who continues to pull the political strings, Nur Otan has promised to improve public services and create jobs—tasks made all the more urgent since the pandemic induced an economic slump.

Four parties are in theory competing with Nur Otan. All of them are staunch supporters of the government, however. None saw any reason to discuss allegations aired by Radio Liberty, an American-funded website and radio station, that the Nazarbayev family owns a global property empire worth some \$800m. One of the parties, Adal, is staffed by several colleagues of Mr Nazarbayev's son-in-law, Timur Kulibayev, a wealthy investor and chairman of a business lobby group. The *Financial Times* recently accused Mr Kulibayev of profiting from inflated procurement contracts during the construction of a gas pipeline—a claim he denies.

Voters can also opt for a party campaigning on rural issues or for one of two parties that loyally assisted the government in the outgoing parliament: Ak Zhol, which is led by a former functionary from Nur Otan, and the People's Party of Kazakhstan. The National Social Democratic Party, a more credible opposition force, declined to run after receiving an unwelcome endorsement from Mukhtar Ablyazov, a Kazakh oligarch based in France whose own political movement is banned. Determined to act as spoiler, Mr Ablyazov is now urging his supporters to back Ak Zhol, which will allow him to depict its voters as fans of his, whatever their true intentions.

Since Mr Tokayev promised greater pluralism, not a single new party has received the necessary government approvals to register. "No one is erecting any obstacles for them," Marat Beketayev, the justice minister, insisted last month. Indeed, the ►►



Potemkin polling stations



▶ government claims to have made it easier for new parties to register, by reducing the number of avowed supporters required. The changes were part of a package of reforms billed as creating what the president called a “Listening State”.

Yet the authorities have still found reason to refuse eight applications to form new parties over the past two years. Most recently it turned down Nurzhan Altayev, an ex-MP expelled from the ruling party for questioning the government’s handling of the pandemic, on the ground that some of the people on the list of supporters he pro-

vided were dead. “We see that Tokayev’s promised reforms were just idle talk,” complains Zhanbolat Mamay. His attempt to register a party last year failed when several delegates were arrested on their way to its founding conference.

International observers monitoring previous elections have complained of ballot-rigging. This time there will be little scrutiny. The Organisation for Security and Co-operation in Europe is sending a delegation of just 35, even though Kazakhstan covers an area the size of western Europe. Draconian new restrictions have hobbled

domestic monitors, leading Maria Lobacheva, who campaigns for greater popular engagement with politics, to label the election an “insiders’ get-together from which observers and voters are excluded”. Some activists are calling for street protests like those that accompanied Mr Tokayev’s election as president in 2019. But this year apathy may trump anger, if the scant turnout at recent demonstrations is any guide. Others are urging citizens to express dissatisfaction by spoiling their ballots. Yet others suggest a boycott. It is all the political competition the country is likely to get. ■

## Banyan Cosmic wobbles

*Is North Korea’s dictator losing his touch?*

WHEN KIM JONG UN, North Korea’s third-generation despot, penned a short, bland greeting to his people to run as a splash in the year’s first edition of the state mouthpiece, *Rodong Sinmun*, it triggered an avalanche of speculation among Pyongyangologists—over what Mr Kim did not do. Since the founding of the communist state, a near-annual staple has been a prolix new year’s address by the country’s leader, trumpeting the regime’s accomplishments and the glories to come. Like Chinese emperors conducting Confucian rites, the address confirmed the Kims at the summit of a divinely ordained order. Unlike his father and grandfather before him, Mr Kim, in power since 2011, has typically delivered the speech in person. Yet last year he simply published a long screed, and this year there was no paean at all.

Perhaps Mr Kim was keeping his powder dry for an important congress of the ruling Workers’ Party of Korea, only the second since 1980? That opaque conclave duly opened on January 5th—without any ritual address from the leader. In its place was a bald admission of failure. The goals of his country’s five-year economic plan, launched in 2016 and promising sunlit uplands, were, Mr Kim admitted, “immensely under-achieved in almost all sectors”.

Although the Kim dynasty is founded upon myth and mendacity, he could not have easily dissembled. Last year’s economic outcomes in an already broken country were dire. Trade collapsed by an estimated 80% (just \$1.6m of goods officially crossed the border with China in October). The informal markets and private enterprise upon which millions of North Koreans now depend have struggled to fill the gap. Shortages are growing, with the prices of vegetables

and fruit rising sharply. Even upscale supermarkets in Pyongyang, the pampered capital, have run out of sugar, cooking oil and toothpaste, according to NK News, a website based in Seoul.

Closing the borders in early 2020 in response to the covid-19 pandemic came on top of North Korea’s diplomatic isolation. For both acts of self-harm, the blame lies squarely with Mr Kim. He calculated that provocative missile and nuclear tests would force America to negotiate. For a time this strategy seemed as if it might work on President Donald Trump, who expressed admiration for the North Korean ruler. But Mr Kim overplayed his hand. Talks failed, and sanctions were only tightened. Perhaps Mr Kim hoped that a second term for Mr Trump could get the personal chemistry fizzing again. Instead, he faces a level-headed Joe Biden.

As for the coronavirus, Mr Kim saw it as a threat to his regime and shut the crucial border with China—border guards even shot at storks suspected of carrying the virus. The country’s decrepit health system could surely not handle a pandemic.



Meanwhile, as Benjamin Katzeff Silberstein points out on the Australian National University’s East Asia Forum, admitting foreign epidemiologists would have opened the country to the risk of foreign spies and unsavoury ideological influences. But this extreme response comes at an immense human cost. The economy, says Andrei Lankov of Kookmin University in Seoul, seems to be “beginning to fall apart”. Hunger once again stalks the land.

If he cared about his people, Mr Kim would welcome foreign vaccines, even if outsiders helped distribute and administer them. The party congress would also initiate the kind of market reforms that set communist China and Vietnam on the path of growth (and which North Korea briefly appeared tempted to embark on early in Mr Kim’s rule). Far more likely, the congress will herald a new era of state control over private enterprise, harming livelihoods even more.

Mr Lankov reckons the regime faces its greatest test since a famine more than 20 years ago brought on by the incompetence of Mr Kim’s late father and grandfather. The regime survived that test despite the deaths of more than 500,000 North Koreans. Today, though, the people know much more about the outside world. They have grown less deferential to authority. And they are used to coping without the state: they might react angrily to the reimposition of central control.

That is not to say that the Kim dynasty is on the brink of collapse. But even small disturbances may be seen, both at home and abroad, as a sign of unravelling. The regime’s rituals project Mr Kim—morbidly obese, smoking heavily and cosseted in his palaces—as the irreproachable bearer of a heavenly mandate. It is a message he may soon need to reinforce.



## Islam in Japan

## Hiji hajis

BEPPU

**The growing number of Japanese Muslims lack the facilities they want**

EVERY FRIDAY scores of Muslim men and women stream into a mosque in an unassuming four-storey building in Beppu, a hot-spring mecca on Kyushu, the most southerly of Japan's big islands. Many are students who study nearby at Ritsumeikan Asia-Pacific University (APU) and work part-time at the hotels around town. Others have come to man the fishing boats and shipyards that the ageing and shrinking local population can no longer fully staff.

The ranks of worshippers have grown in recent years, as the government has sought to attract more foreign workers and students. The number of Muslims living in Japan, though small, has more than doubled in the past decade, from 110,000 in 2010 to 230,000 at the end of 2019 (including as many as 50,000 Japanese converts), according to Tanada Hirofumi of Waseda University. The country boasts more than 110 mosques. That is a welcome change, notes Muhammad Tahir Abbas Khan, a professor at APU and the head of the Beppu Muslim Association (BMA). In 2001, when he first arrived from Pakistan as a graduate student, there were only 24 mosques in the country and not a single one on Kyushu.

Yet while Muslims now have more opportunities to pray, they still struggle to find final resting places. Some 99% of Japanese are cremated, a practice Islam forbids. The central government has no system for catering to the needs of foreigners with different customs, in part because foreign workers are seen as visitors rather than permanent migrants. Most prefectures, including Oita, where Beppu is located, have no Muslim cemeteries. The BMA has spent years trying to construct one in Hiji, a constellation of hamlets in the hills beyond Beppu, but local resistance has stalled the project. "If I die today, I don't know where I will be buried," Mr Khan laments.

The dispute over the cemetery has become a proxy for a broader debate about foreigners' place in Japanese society. Some Japanese have embraced their new neighbours, unfamiliar customs and all. "Since they're Japanese now, we should start understanding who they are and what their culture is," argues Kawabe Yumiko, a town councillor who supports the cemetery. "A small town can be international and diverse." Others disagree. "If they got Japanese nationality, they should follow Japanese customs and cremate the bodies," says Eto Kiyotaka, another councillor, who

initiated a petition against the cemetery.

The BMA began searching for a burial ground nearly a decade ago. The local Catholic church agreed to share its cemetery while the BMA looked for one of its own. Talks with the city government went nowhere, but a friendly Buddhist monk helped the BMA find a plot on an uninhabited hillside in Hiji, not far from a Trappist monastery with a disused cemetery. Mr Khan says the group has sunk ¥60m-70m (\$582,000-679,000) and nearly three years into the project. Time has now run out: the Catholic cemetery is full. But as the start of construction approached, residents of nearby hamlets raised fresh concerns. Will the bodies contaminate the local water supply? Might the corpses fall out of the hillside during an earthquake?

The idea of burying bodies strikes many in Hiji as unclean. "It's not something concrete, just a feeling," says Mr Eto. "We won't be able to drink the water with comfort." Mr Eto has lived his whole life in a small hamlet of traditional homes and terraced rice paddies. So too did his forebears as far back as he can count, at least four generations. Until the hearings over the cemetery began, he had never met a Muslim. He says he has nothing against the religion, but worries that bacteria will leach into a reservoir close to the planned site. He wonders why the city does not allow interment in public cemeteries: "If the government isn't doing it, there must be some problem."

Ms Kawabe, in turn, wonders if it is real-

ly the water that concerns her compatriots. Scientific evidence about the safety of burials goes ignored. Her support for the cemetery prompted a flurry of angry calls and letters. "They say to me, 'You're Japanese, why are you on the side of the Muslims?'" Locals fret about an influx of visitors and the prospect of an Islamic school opening next. "Many people are scared," she sighs.

That is a shame, Mr Khan says, because Japan is otherwise "a nice place to live". Muslim migrants appreciate Japan's security, cleanliness and functionality. "Anzen, anzen," coo a group of Indonesian fishermen in Tokyo, repeating the Japanese word for "safety" when asked about life in Japan. The people are "so kind", says Ben Madaliev, who came from Uzbekistan on a scholarship to study business at APU. Colleagues at his part-time job accepted his need to pray five times a day, and now even remind him when he is late for his prayers. Though negative stereotypes about Islam abound, most Japanese have little first-hand experience of it and remain open-minded. "It's much better than going to the West," reckons Ali, an Uzbek student living in Tokyo.

In some ways, integration has been progressing. The airport in Fukuoka added a prayer room, notes Mr Khan. Halal shops and restaurants remain few and far between, but more are opening, especially as more Muslim tourists from South and South-East Asia visit Japan. Prefectural officials in Oita asked for the BMA's help to set up a system of certification for local restaurants. Some hot springs even sell bathing shorts for Muslims. The community in Beppu won over locals by cooking and distributing food to those displaced by a big earthquake in 2016. They host yearly festivals and weekly free dinners at the mosque, aimed at establishing good relations with their Japanese neighbours. "We're trying to integrate," Mr Khan says. "We adopted Japan as our home country." ■



A far cry from kimonos





## Hong Kong

# Cut down in the primary

HONG KONG

**Police arrest more than 50 campaigners and politicians under its national-security law**

THE NATIONAL-SECURITY law which China imposed on Hong Kong in June was meant, some of its backers once insisted, to rely more on its bark than its bite. During its first months in force, only 35 people were arrested (just four were charged) under the bill, which criminalises acts such as inciting secession and colluding with a foreign power. The picture changed dramatically on January 6th when, in a pre-dawn raid, nearly 1,000 police officers fanned out across the city to search 72 premises and arrest 53 pro-democracy politicians and activists on grounds of subversion.

Those rounded up had stood for election in, or helped to run, an unofficial “primary” ballot to choose candidates for elections for the 70-seat Legislative Council (Legco) that had been scheduled for last September. Among the arrested are Benny Tai, an academic and leading democracy activist. Lester Shum and Jimmy Sham, organisers of some of the mass protests that

roiled the territory in 2019-20, were also hauled in, along with prominent former legislators including Eddie Chu, James To and Alvin Yeung. So too were civil-society figures, such as Lee Chi-yung, a campaigner for people with disabilities; Jeffrey Andrews, a social worker; and John Clancey, a human-rights lawyer who acted as treasurer for an outfit organising the primary. Mr Clancey, an American, is the first foreigner to be apprehended under the law.

More than 600,000 Hong Kongers—around 8% of the population—voted in the primary. At the time, Hong Kong’s chief executive, Carrie Lam, described the process as “subversive”, though it was hard to see why. Its point was to provide a unified slate

that had a better chance of winning seats and even a majority in a chamber selected by a voting system that is heavily rigged in favour of the establishment. As it turned out, the process was moot. Mrs Lam postponed the elections by a year, conveniently attributing the move to the covid-19 pandemic. In November China’s national parliament bypassed Hong Kong’s own courts to disqualify four pro-democracy legislators. The 15 remaining opposition legislators resigned in solidarity.

Mainland officials and media thundered their approval of the arrests. Explaining them, John Lee, Hong Kong’s secretary of security, accused the pro-democracy camp of “aiming to win 35 seats”, as if their goal should be to lose. Mr Lee talks darkly of a plot to overthrow the government. Prosecutors say the opposition had a “mutual destruction” plan to grind the government to a halt and then overthrow it. A decisive victory would have given them power to vote down the budget. In such an event, Mrs Lam would have to dissolve Legco. If the new Legco were again to reject it, the chief executive would be obliged to step down. The process is enshrined in the Basic Law, Hong Kong’s mini-constitution.

Yet that law now plays second fiddle to the central powers’ broader aims. In any functioning democracy, winning a legislative majority is the point. Hong Kong’s sys- ▶▶

→ Also in this section

35 Female comedians

36 Chaguan: A flawed EU-China deal



tem, by contrast, is not only undemocratic, it is executive-led. Just as Britain's colonial rulers never intended an opposition to gain legislative control, so Hong Kong's overlord in Beijing is fierce in never countenancing it. The arrangement sits at odds with China's promises of autonomy and gradual democratisation in Hong Kong. Some establishment figures in the territory (admittedly a minority) struggle with the contradiction. With a troubled logic, a senior government adviser says the democrats' attempts to gain control of Legco were akin to Donald Trump's supporters storming the Capitol.

Those arrested have yet to be charged. They will be tried in Hong Kong's still independent courts, which demand far higher evidentiary standards than Communist Party-controlled ones on the mainland. In particular, courts will have to be persuaded that the threat of subversion was real and imminent. It is possible, says a second government adviser, that many of those arrested will not be charged, and that even those charged may get off. If that happens, calls for judicial "reform" made in mainland newspapers and by Hong Kongers keen to curry favour in Beijing will only redouble. Their gripe is that too many people charged with anti-government activities get off.

The courts, in other words, could become the central government's next target. For now, though, the arrests mark an escalation in repressive tactics in Hong Kong. The national-security law has already had a powerful deterrent effect: the mere threat of harsh treatment for anyone falling foul of the law—including life imprisonment or shipment to the mainland to face trial under Chinese jurisprudence—has helped to keep the streets clear of protesters. But until now the purging of pro-democracy campaigners has tended to rely mainly on pre-existing laws. Jimmy Lai, a combative media mogul, is the most notable exception. He was charged in December with alleged collusion with foreign forces.

Yet kneecapping the opposition still leaves the chief executive beleaguered on all sides. Many financial and other businesses tied to China applaud the crackdown with outward calm, while raking in money from buoyant financial markets. But other international executives, who are concerned about Hong Kong as a regional centre, are starting to speak out. This week the head of Sweden's chamber of commerce, Kristian Odebjör, tweeted that Hong Kong's crackdown was having "a significant negative impact on business". As Hong Kong's image deteriorates, he added, it is getting harder "to defend why you should maintain costly operations here".

Mrs Lam is deeply unpopular among those in Hong Kong who are critical of the government's cosiness towards big business and of its poor record on everything

## Female comedians

## A woman walks into a bar

BEIJING

Stand-up is booming. Women are taking centre-stage

"MEN ARE adorable," begins Yang Li in a sketch first aired last year. "But mysterious...After all, they can look so average and yet be so full of confidence." It seemed a gentle dig by the newly crowned "punchline queen" of "Rock and Roast", a television show starring amateur comics. But as Ms Yang's fans spread the gag, male netizens threw a tantrum. Last month a group of them reported the 28-year-old to the broadcast regulator for "sexism". An academic at Peking University called Ms Yang and her admirers "internet feminists, the most emotional and least tolerable people".

Long the stars of Chinese joke-making, men are unhappy about being the butt of it. Chizi, a popular male contestant on "Rock and Roast" with a penchant for boorish jokes about women, sniffed that Ms Yang was "not performing comedy". Guo Degang, a master of *xiangsheng*, a witty and often bawdy form of traditional comedy involving banter between two people, recently said he would not recruit women for his troupe

("out of respect", he said). Very few women perform *xiangsheng*.

Western-style stand-up comedy has taken off since it appeared in China a decade ago. It is proving to be a more accessible art form for female comics. With stand-up, says Evangeline Z, a 27-year-old comedian in Shanghai, "there are no barriers to joining as long as you can talk." Women bring new themes to the stage. On the latest season of "Rock and Roast", a vlogger quipped about coping with depression, twins joked about body-shaming and a car engineer about her career.

The show, which began in 2017, has been a boost for Chinese stand-up and female participation in it. Evangeline Z says the form of comedy is "huge" in Shanghai. And she reckons up to half of the city's 50-odd weekly performances are by women. But male and female comics alike warn spectators that what they are about to say could be offensive and they should not take offence. Xiao Ju, a 22-year-old part-time comedian, also in Shanghai, says that showgoers expect to come in for "a bit of easy laughter", so are ruffled when the ribbing reveals something about themselves.

Female comedians elicit stronger reactions from the audience than male ones, says Xiao Ju. Many people are still shocked when women swear on stage. A gag about a prostitute told by a male comic draws tuts if delivered by a woman. "Sex is a perilous topic," says Xiao Ju. "So are shit, piss and farts. If a man jokes about these, everyone laughs. If a woman does, she is disgusting." For fear of offending, many stick to crowd-pleasing themes like families and jobs.

Ms Yang has used the backlash against her gag to create a new one. It involves an exchange with a male colleague who approvingly notes her testing of men's limits. Her mock-incredulous riposte: "Do men *have* limits?"



Yang Li packs a punchline

from reducing inequality to road safety and recycling plastics. At the same time, the second adviser points out, she is under pressure from the pro-establishment camp. Those with business on the mainland blame her for not responding to the pandemic with tighter lockdowns and more intensive testing so that restrictions on travel to the mainland can be eased. Others eyeing Mrs Lam's job when her term is over next year delight in attacking her.

Even central-government officials hold her in almost palpable disdain for drawing Hong Kong into a political mess.

In an unpublished survey of 250 students, academics at Chinese University and the University of Hong Kong found 87% had no confidence in their government. The authors warned of a "powder keg" that could engulf the city again. That may explain why officials are trying so hard to nip opposition in the bud. ■



## Chaguan | Winners and losers

*Weary cynicism, not naivety, explains a flawed new EU-China commercial pact*



**B**UOYED BY A growing economy, cheered by a domestic public united by the fight against covid-19, and eager to start shipping vaccines to friends around the world, China's rulers feel history turning their way. A recurring phrase in their speeches hails "changes unseen in a hundred years". Bluntly, Communist Party chiefs feel China is rising and democratic countries—battered by recession and racked by partisan disputes—are falling behind.

As 2021 dawned, the European Union offered China a further boost by agreeing to a commercial pact that will bind some powerful European companies still more tightly to China. The deal brushes aside concerns about dependence on Chinese markets. It tackles allegations of forced labour in supply chains by accepting promises that China will make "continued and sustained efforts" to ratify international conventions on workers' rights.

Politically, China sees the deal—a comprehensive investment agreement whose benefits mostly flow to a few German carmakers, European insurance companies and other well-connected firms—as an early victory over Joe Biden. Aides to America's president-elect had hinted publicly that Europe might like to wait and co-ordinate efforts to curb China's worst trade and human-rights abuses. Those hints were ignored. Hosting EU ambassadors for lunch just before Christmas, the foreign minister, Wang Yi, praised Europe's "strategic autonomy". The phrase was first dreamed up by French politicians. Mr Wang's use of it sent a clear message. As envoys at the lunch tell it, China was thanking the agreement's main backers, notably Germany's chancellor, Angela Merkel, for refusing to join America in the one alliance that Chinese leaders fear: a global coalition of like-minded nations willing to exclude China from sensitive supply chains or to block investments, in defence of democratic norms and freedoms.

Critics accuse EU leaders of shocking naivety. They were particularly dismayed when the president of the European Commission, Ursula von der Leyen, claimed that the agreement promoted Europe's "core values", and that China's vague commitments provided "a lever to eradicate forced labour". Actually, it is not fair to call European leaders naive about the investment accord. Rather, their motives are a mix of self-interest, cynicism about Europe's limited clout and pessimism about the prospects for joint action with Mr

Biden's America. A European summarises the decision-making process: "We had an economic interest in concluding a deal. The Chinese had a political interest in demonstrating that China is not isolated. There was a perception we would get nothing more."

Views among European ambassadors and business bosses in China have hardened noticeably as the country takes one illiberal turn after another under President Xi Jinping, an austere autocrat. In particular, 2020 was a turning-point. A new national-security law trampled on Hong Kong's Western-style freedoms. Chinese troops killed Indian soldiers in a border clash. Intent on smothering discussions of China's disastrous early handling of covid-19, Chinese diplomats threatened governments across the West, and were praised at home as patriotic "wolf warriors". China banned many Australian imports to punish that country for suggesting an independent probe into the pandemic's origins.

Early in 2019 the EU published a strikingly honest China strategy, calling the country a partner, a competitor but also a "systemic rival". Among Europeans charged with managing relations with China, that tripartite view of China has not changed. The investment agreement is best understood as a holdover from a time when Europe was unwilling to acknowledge deep ideological differences with China. The EU's negotiating mandate for the deal dates from 2013. With its focus on market access and level playing fields, it sets out to manage China as a partner and competitor, says Reinhard Bütikofer, a German Green and chairman of the European Parliament's delegation for relations with China. "It almost completely ignores systemic rivalry," he objects, speaking by Zoom from Berlin. He expects the parliament, which must approve the pact, to seek stronger commitments on labour rights, notably in factories using workers from Xinjiang, a western region where Muslim minorities are governed with an iron fist.

Mr Bütikofer's approach is increasingly popular among Western elected politicians. It is a minority view among European bigwigs in China. Most argue for trade talks that seek whatever concessions are going, then for separate efforts to press China into curbing its worst abuses, and, most important, for work at home on anti-subsidy measures and security-screening of investments.

### **China is not about to change: time to build better defences**

Chinese voices insist that clashes over values are not inevitable, at least when talking to foreigners. Wang Yiwei, director of the EU studies centre at Renmin University, chides Americans for thinking like religious missionaries about engagement with China. In contrast, "Europe is secular; it is not seeking to convert China to a multiparty system or a free press," he asserts, approvingly.

European sources in Beijing ascribe China's willingness to cut a deal, after much foot-dragging, to two factors. First, to the belief of Liu He, a deputy prime minister in charge of economic policy, that some European competition is good for state-owned firms. Second, to a decision by Mr Xi to do a deal before Mr Biden takes office.

Ask European envoys if the EU erred by agreeing to a deal now, and they are divided. Some insist that Europe risked irrelevance if it had waited for a new American president. They add that this modest accord does not preclude co-ordinated action later. Others regret the decision to hand China a political win at Mr Biden's expense. Not one of the diplomats argues that Europe underestimated its leverage, and could have struck a better deal. Among Westerners in Beijing, bleak realism predominates. Mr Biden says he will rally the democratic world behind a new China strategy. He has his work cut out. ■





## South Africa

## Bourgeois blues

CENTURION

**Public-sector wage cuts would pit the ruling party against the black middle class it helped to create**

**T**HE HEADY years after apartheid gave rise to what advertisers and the press called “black diamonds”. Portrayals of newly rich black South Africans were often crass, highlighting their flashy cars and fancy homes that had been out of reach in the era of white rule. Many of the gaudiest examples involved people close to the ruling African National Congress (ANC). In 2010 Kenny Kunene, a businessman and convicted fraudster who later starred in “So What: Big Money, Big Dreams”, a TV show, was criticised for spending 700,000 rand (then worth \$47,000) on a party where he ate sushi off scantily clad women. His response: “It cost more than that.”

Such tales were entertaining, but they were not the norm. More representative of the milieu of middle-class black South Africans is the Reeds, a suburb in Centurion, near Pretoria, full of Toyotas and modest homes roofed with terracotta tiles. Under

apartheid its position near the administrative capital made it popular among Afrikaners (whites of mainly Dutch descent) with government jobs. Today it is mostly home to black South Africans, who joined the public sector en masse after the first democratic elections in 1994.

Shortly after that vote Ayanda (not her real name) and her husband got good jobs in the civil service. In 1995 they moved to the Reeds with their two children. They were the first black family on the street. Her white neighbours were initially hos-

→ **Also in this section**

**38 The early days of globalisation**

**39 War and sport in South Sudan**

**39 Tension in the Gulf**

**40 Syrian refugees stay put**

tile, but “we were just so happy to have our own house,” she says. “We’re here in the suburbs because of the ANC.”

That kind of loyalty may soon be tested. South Africa is in a fiscal crisis. The share of public debt to GDP has risen from 22% in 2008-09 to an estimated 82% in the current fiscal year, 2020-21. The treasury forecasts a deficit of 15% of GDP. The share of tax revenues spent on servicing debts was 10% in 2010. It was about 22% in 2020, and will keep rising. The pandemic brought forward the reckoning, but the more important causes were a decade of slow growth and reckless spending by the ruling party.

To try to close the deficit Tito Mboweni, the finance minister, is targeting the public-sector workforce. South Africa does not have an especially large one, but it is well paid (see chart on next page). Public-sector pay went up by an average of two-thirds in real terms between the fiscal years ending in 2007 and 2019, far faster than the rise in the private sector. Mr Mboweni has proposed cutting the public payroll by 160bn rand (25% of the total in 2019-20) over “the medium term”. It is the first salvo in a battle over the budget that will profoundly affect the country—and the ANC’s relations with the black middle class it helped to create.

South Africa’s black middle class pre-dates democracy. In the first half of the ▶▶



► 20th century there was a smattering of black professionals, including mission-educated doctors, teachers and lawyers, such as Nelson Mandela. In 1965 Leo Kuper, a sociologist, wrote “An African Bourgeoisie” about the middle class under apartheid. From the late 1970s, as white rule began to unravel, the government made cursory efforts to encourage the growth of a black bourgeoisie that might dampen the ANC’s revolutionary fervour. As early as 1988 *Time* magazine wrote about what it saw as black yuppies, or “Buppies”.

Yet they still made up a minority of middle-class families in a country where three-quarters of people were black (today the share is more than four-fifths). Academics differ over how to define the middle class, but agree that blacks have become a clear majority within it. Ronelle Burger and her colleagues from Stellenbosch University reckon that their share doubled from 32% in 1993 to 64% in 2012. A more recent paper by the economists Rocco Zizzamia, Simone Schotte and Murray Leibbrandt estimated that the share rose from 47% in 2008 to 64% in 2017.

Most black South Africans, however, are not middle-class. According to the economists’ paper, which categorised people based on their income stability over many years, just 18% of black South Africans are secure enough to be deemed middle-class. Almost half are “chronically poor” and nearly all the rest move in and out of want. Many deemed middle-class support extended families and have large debts.

The key to middle-class stability, points out Mr Zizzamia, is a job. And the most secure jobs are in the public sector, where blacks have climbed through the ranks more successfully than they have in business. Some 66% of senior public-sector managers and 56% of those in state-owned firms are black, according to the Commission for Employment Equity, a watchdog, compared with 16% in the private sector.

“The black middle class is overwhelmingly rooted in public-sector employment,” argues Roger Southall, an academic. He points out that the ANC has blurred the line between party and state. It has passed

affirmative-action laws (as well as policies of “black economic empowerment” that have enriched a few) and “deployed” party members in government positions.

Mr Mboweni’s proposals have been met with fierce opposition. A legal challenge by trade unions was dismissed in December, but they may yet call for strikes. This dispute is just the first in what may be a long fight over who bears the brunt of austerity.

It is a battle that could fray the ties between the ANC and the black middle class, which is not homogenous. Honest civil servants are angry with the ruling party because its corruption has given anyone working in government a bad name, notes Ivor Chipkin, the author of “Shadow State”. Nevertheless, because of its role in creating jobs, support for the ruling party has remained “pragmatic” and “sustained”, says Amuzweni Ngoma, a researcher.

Writing in 2016, Mr Southall speculated about what would happen to this conditional loyalty to the ANC if there were a “financial meltdown”. He made a comparison with Zimbabwe, where the middle class at first did well under Robert Mugabe’s regime. But as he ran the country into the ground and destroyed its economy, these Zimbabweans either emigrated or voted in greater numbers for the opposition.

There is another salutary story. The National Party, which ran South Africa from 1948 to 1994, used its control of the state to increase the Afrikaner middle class. But the madness of apartheid eventually undermined the economy and, in turn, weakened support for the party among its middle-class base—the sort of people who once lived in the Reeds. If the ANC impoverishes the class it helped to build, it too will struggle to hold on to power. ■

Egypt’s trade with Africa

## Monkey business

How baboon-worship contributed to early globalisation

**T**HOTH HAD a broad bailiwick. He was the god of wisdom, writing and many strands of alchemy. Ancient Egyptians worshipped him alongside Ra, the sun god. So it is no wonder they had such great respect for the baboon, understood to be Thoth’s earthly manifestation in the pantheon of blessed beings.

New evidence uncovered by Nathaniel Dominy and his team at Dartmouth College confirms that Egypt’s early seafarers ventured to faraway Punt in search of the prized primates. The kingdom of Punt covered an area spanning much of Africa’s east coast. Travelling thousands of miles there and back would have required advanced nautical skills.

Ancient Egypt’s most coveted species was *Papio hamadryas* (the sacred baboon), frequently depicted in paintings. Great care was taken when mummifying it. Linen was wrapped around the entombed animals’ tail and limbs.

The researchers examined two such specimens that would have lived in the period of the New Kingdom (1550-1069BC) and now reside in the British Museum. The strontium isotope composition of their teeth reveals the environment in which they grew.

By comparing these data with the dental strontium profiles of the baboons in east Africa today, the ancient animals’ place of origin can be located in modern-day Eritrea, Ethiopia or Somalia. These countries are all thought to have formed part of Punt. (Today’s Puntland is a north-eastern region of Somalia.)



A baboon to trade

*Papio anubis* (the olive baboon) has been found in tombs and temples, too. But the Egyptians were less fond of it. Five examples of this species from the Ptolemaic period (305-30BC) showed a strontium profile that indicates they were born in Egypt, suggesting that by the time of the last pharaoh the Egyptians were breeding baboons at home.

Mr Dominy says that the first leg of what became the spice route was probably the result of at least 1,100 years of trade between Egypt and Punt. Though baboons were the most valued, many other goods changed hands, such as incense. Egyptologists argue this marked the beginning of global commerce.

### Pay to play

Public-sector wages, 2019\*, % of GDP

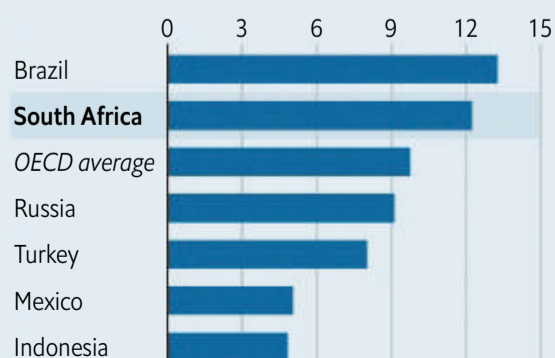

Source: OECD

\*Or latest available



## War and sport

## A shot at peace

JUBA

## How a basketball star is trying to heal South Sudan

THE PEOPLE of South Sudan are among the tallest in the world. That helps explain why several of them have had stellar careers playing basketball abroad. One is Luol Deng, a former all-star in America's National Basketball Association (NBA). Mr Deng, who retired in 2019 after 15 seasons on the hardwood for the Chicago Bulls and other teams in the NBA, took over as coach of South Sudan's national team in November. Now he is using the sport to try to mend his war-torn motherland.

In December, for the first time in its history, South Sudan won enough games to qualify for the African basketball championship, known as AfroBasket. That is no small feat for a team that is relatively new to international competition. For five of the ten years that South Sudan has existed as a country, it has been beset by civil war. Of its 12-member squad, all but one player grew up abroad.

The war has directly led to the deaths of almost 200,000 people, and perhaps caused twice as many deaths indirectly through hunger and disease, according to a study in 2018 by researchers at the London School of Hygiene and Tropical Medicine. Mr Deng, who also funds the national squad, hopes it will help bring the country together and change its image abroad. "We're doing something that's bigger than basketball," he says. "There are people that are depressed and hungry and struggling... That two-hour game gives them pride to keep going."

The young minister of youth and sports, Albino Bol Dhieu, is a believer. He hopes that what has been "spoiled by politics can be fixed by sports". He plans to build a sports complex and at least one basketball court in each of the country's ten states and three administrative areas. Quite how he will pay for this is not clear. The government's budget set aside the equivalent of just \$5.3m, or less than 1% of spending, for his ministry. By contrast, nearly \$130m was allocated for security.

With its recent performance the national team has risen a remarkable nine places (to 98th) in the rankings of the International Basketball Federation, known as FIBA, the sport's global governing body. Locals hope that when AfroBasket tips off in August, it will provide more than just national pride. They hope that the team's success will inspire young men to put down their guns and start shooting hoops. ■



## The Gulf

## The Arabs get back in line

BEIRUT

## As Iran stirs up trouble

THE THIRD day of January marked a year since America assassinated Qassem Soleimani, a talismanic Iranian general who marshalled militias across the Middle East. The mood was febrile. American officials feared commemorative reprisals. Muhammad Javad Zarif, Iran's foreign minister, tweeted that "intelligence from Iraq" indicated an American "plot to FABRICATE pretext for war". The *USS Nimitz*, an American aircraft-carrier, having been ordered home from the Persian Gulf days earlier as a conciliatory gesture to Iran, was told to stay put. In the end, January 3rd passed without incident. Yet the day that followed was anything but uneventful.

On January 4th Iran said it had resumed enriching uranium to 20% purity, a level that is nine-tenths of the way to weapons-grade, at its underground Fordow facility. Under the terms of a nuclear deal signed by Iran and six world powers in 2015, but abrogated by America in 2018, Iran is forbidden to enrich anything at all at Fordow, let alone to such levels.

In response to President Donald Trump's "maximum pressure" campaign of sanctions, Iran had already violated several parts of that deal over the past two years. Then, on November 27th, Mohsen Fakhri-zadeh, Iran's top nuclear scientist, was assassinated, probably by Israel. Iran's parliament promptly passed a law requiring the government of Hassan Rouhani, Iran's president, to produce and store at least

120kg of 20%-enriched uranium a year, among other steps. Mr Rouhani had tried to defer these moves, but eventually declared himself "bound" by the legislation.

The 120kg figure is no coincidence: it is half the amount thought necessary for a single bomb (if the uranium is enriched further). Yet Iran's probable aim is not to make one—American intelligence agencies believe Iran largely closed a covert nuclear-weapons programme in 2003. Rather, it may be creating leverage in order to compel America to return to the nuclear deal. Mr Zarif emphasises that Iran's violations of the deal are "fully reversible".

Joe Biden, America's president-elect, has promised to rejoin the agreement if Iran moves back into "strict compliance". Iran is eager to hold Mr Biden to his word by demonstrating that it has a good hand to play if sanctions are not lifted. It has also hinted at more cards up its sleeve. On January 5th a spokesman for Iran's atomic-energy organisation noted that Iran could enrich uranium to 60%, a level that would have no plausible civilian use but would shorten the path to a bomb.

Things could go awry before Mr Biden takes office on January 20th. Mr Trump has held Iran responsible for rocket attacks on Americans in Iraq, and has contemplated military strikes on Iran's nuclear programme. As well as the lurking *Nimitz*, missile-packed American and Israeli submarines conspicuously surfaced in the ▶▶



► Persian Gulf in December. “I’m very worried about it,” says Mark Fitzpatrick, a former State Department official now at the International Institute for Strategic Studies, a think-tank in London. “[Mr Trump] is capable of trying anything.”

If that were not enough, Iran’s Islamic Revolutionary Guard Corps (IRGC) chose the same day, January 4th, to seize a South Korean oil tanker, ostensibly for “polluting the Persian Gulf with chemicals”. The IRGC is not known for its environmental activism. Tasnim, an IRGC-linked news agency, was more candid. “Seizing the ship”, it said, “is a good pretext for releasing Iran’s blocked money in South Korea, which is about \$8bn.” The previous day, the *Tehran Times*, an Iranian newspaper, had suggested that Iran wanted to use those funds—frozen in response to American sanctions—to buy supplies of covid-19 vaccine. South Korea has sent a destroyer to the region, but says it does not plan to use force. Negotiations are under way between South Korea and Iran.

As Iran was picking these fights, its rivals were smoothing over theirs at a Gulf Co-operation Council summit in the Saudi city of al-Ula (pictured on previous page). Upon landing in Saudi Arabia, the emir of Qatar was embraced by Muhammad bin Salman, the kingdom’s crown prince and de facto ruler. Their hug would have been unthinkable a year ago. In 2017 Saudi Arabia and three other Arab states—Bahrain, Egypt and the United Arab Emirates—imposed an embargo on Qatar, closing their borders and airspace and in effect turning the peninsular nation into an island.

To end the blockade, they insisted, Qatar would have to accede to 13 demands, among them cutting ties with both Iran and political Islamists and closing Al Jazeera, its influential satellite-news channel. The demands were unrealistic by design; Qatar agreed to none of them. Still, the four countries have agreed to restore full diplomatic relations with Qatar, a big step towards ending the dispute. Saudi Arabia has already reopened its borders with the emirate. The Qataris will probably reciprocate by toning down their rhetoric on Al Jazeera and in other media outlets.

Jared Kushner, Mr Trump’s son-in-law and adviser, had spent months pushing for a deal. But the resolution may have less to do with his efforts than with Mr Trump’s defeat in November. The Saudis are wary of Mr Biden and his fellow Democrats, who are angry about the kingdom’s ruinous war in Yemen and its murder of Jamal Khashoggi, a Saudi journalist, in 2018. The Saudis, in turn, are worried about Mr Biden’s talk of re-entering the nuclear deal with Iran, their main regional rival. Ending the blockade of Qatar buys the Saudis some political capital in Washington—which they will probably be quick to spend. ■

## Syrian refugees

# Here to stay, however miserable

BEIRUT

**Making life difficult for the displaced does not compel them to return home**

ON DECEMBER 26TH a scuffle broke out between Syrian refugees and residents of the Lebanese town of Bhanine, north of Tripoli. That night the row, allegedly over unpaid wages, turned ugly. Shots were fired. Armed villagers then set fire to the refugees’ tents, causing them to flee and sleep rough in nearby fields. When they returned the next morning their makeshift camp was little more than a patch of charred debris.

The past year has been difficult for everyone in Lebanon. The country has endured covid-19, the collapse of its currency and a huge explosion at Beirut’s port in August. But the consequences of all this have been particularly bleak for the 884,000 Syrian refugees living there. The United Nations estimates that 89% of them live in extreme poverty (up from 55% in 2019). That means they make under 309,000 Lebanese pounds a month—a sum that is less than half the minimum wage and worth a mere \$36 at unofficial exchange rates.

Some Lebanese politicians, including a former foreign minister, Gebran Bassil, have whipped up public anger towards refugees, blaming them (wrongly) for Lebanon’s economic collapse. The outrage in Bhanine was not an isolated incident: in November, after a Syrian refugee killed a Lebanese man in the northern town of Bcharre, hundreds of Syrians fled amid calls for their expulsion.

Yet for all their difficulties, Syrians in Lebanon are not clamouring to return home. The number of registered refugees has fallen by 23% from its peak of 1.1m in 2014, a decrease of 263,000. Only 55,000 of those have returned to Syria, though. At the average pace over the past five years, it will

take until around 2041 for the last Syrian refugee to leave Lebanon.

Eager to speed their exodus, the Lebanese government has increased pressure on refugees, stepping up deportations and restrictions. In November, when Bashar al-Assad’s regime in Syria hosted a garish conference urging refugees to return to his shattered country, Lebanon was the only Arab state to send a delegation.

Researchers from the Immigration Policy Lab at Stanford University and ETH Zurich, a Swiss university, argue that such measures will fail. In a working paper published in November, they found that 63% of Syrian refugees in Lebanon hope to return home one day. Just 5%, however, expected to do so within the coming year, a stark gap between what refugees intend to do and what they are actively preparing to do. Moreover, they found no correlation between the well-being of refugees in Lebanon and their desire to return home.

What matters, they argue, are the conditions not in Lebanon, but in Syria—and those are increasingly bleak. Extortion starts at the border, where the Syrian government requires every citizen returning home to convert \$100 into the debased local currency. Once inside, Syrians encounter queues in which people wait for hours, sometimes days, to obtain essentials such as bread and fuel. Those returning face the threat of forced conscription by a regime starved of manpower, and of arbitrary detention by a regime starved of cash. A Syrian activist group, founded by a former inmate in the notorious Sednaya prison, reckons the government has squeezed \$900m in bribes out of detainees’ families since the war began.

The trend is similar in Egypt, Jordan and Turkey, which together host two-thirds of the 6.6m registered Syrian refugees (see map). Turkey has been the most hospitable, offering access to education and social services, though official and public hostility is mounting. Egypt and Jordan have been less generous, but still offer more support than Lebanon. Regardless of conditions, the results are the same: in all three countries the number of registered refugees has stayed roughly the same since 2017. Without a real change in Syria, the refugees scattered across the region (and in Europe) are probably there to stay. And as long as Mr Assad is in power, no real change is expected. ■

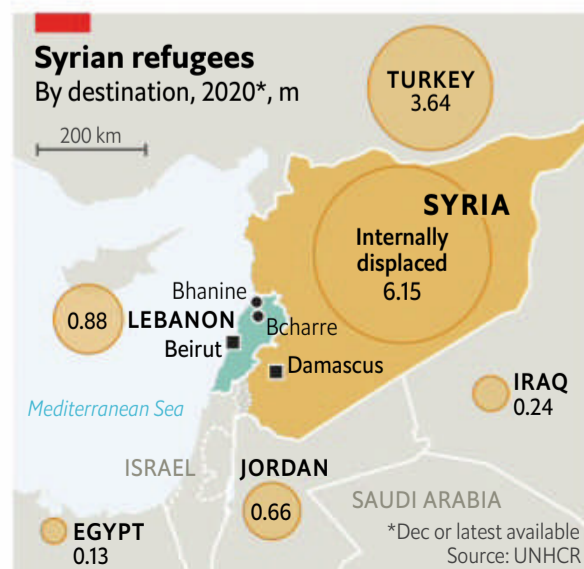



# TQ

The Economist  
Technology Quarterly:  
**Light**

→ January 9th 2021

3 Einstein's revolution

5 Sunlight and semiconductors

7 Starlight and information

9 The ubiquitous laser

11 Appliance to science



## The liberation of light



The race for a vaccine.

More for you to uncover.

*The race for a vaccine.  
Will America heal?  
The green recovery?  
The fight for equality.  
And much more.*

The  
Economist

# The World in 2021



Our definitive guide to the year ahead.

Buy it now in print at [shop.economist.com](https://shop.economist.com) or on newsstands. Available digitally to subscribers at [economist.com/worldin21](https://economist.com/worldin21)





A hundred years of bright ideas

## The liberation of light

The revolutionary theory of the nature of light which won Albert Einstein the 1921 Nobel prize for physics went on to remake the world. Oliver Morton surveys a century of innovation

ALBERT EINSTEIN won the 1921 Nobel prize for physics in 1922. The temporal anomaly embodied in that sentence was not, alas, one of the counterintuitive consequences of his theories of relativity, which distorted accustomed views of time and space. It was down to a stubborn Swedish ophthalmologist—and the fact that Einstein’s genius remade physics in more ways than one.

The eye doctor was Allvar Gullstrand, one of the five members of the Nobel Committee for Physics charged with providing an annual laureate for the Swedish Royal Academy of Sciences to approve. Gullstrand thought Einstein’s work on relativity an affront to common sense (which it sort of was) and wrong (which it really wasn’t). Every year from 1918 on, the committee received more nominations for Einstein than for any other candidate. And every year, Gullstrand said no.

By 1921 the rest of the committee had had enough of settling for lesser laureates: the only decision which could be made unanimously was not to award the prize at all. Amid great embarrassment the academy chose to delay the 1921 prize until the following year, when it would be awarded in tandem with that of 1922. This gave Carl Wilhelm Oseen, a Swedish physicist newly appointed to the committee, time for a cunning plan. He nominated Einstein not for relativity, but for his early work explaining light’s ability to produce electric currents. Though Gullstrand was still peeved, this carried the day. In November 1922 Einstein was awarded the 1921 prize “for his services to theoretical physics, and especially for his discovery of the law of the photoelectric effect”.

This adroit bit of face-saving also seems, a century on, fully justified. Einstein’s first paper on the nature of light, published in 1905, contained the only aspect of his work that he himself ever referred to as “revolutionary”. It did not explain a new experiment or discovery, nor fill a gap in established theory; physicists were quite happy treating light as waves in a “luminiferous aether”. It simply suggested that a new way of thinking about light might help science describe the world more consistently.

That quest for consistency led Einstein to ask whether the energy in a ray of light might usefully be thought of as divided into discrete packets; the amount of energy in each packet depended on the colour, or wavelength, of the light involved. Thus the “law” mentioned in his Nobel citation: the shorter the wavelength of a beam of light, the more energy is contained in each packet.

Eight years earlier, in 1897, experiments carried out by J.J. Thompson had convinced his fellow physicists that the “cathode rays” produced by electrodes in vacuum tubes were made up of fundamental particles which he called “electrons”. Over time, Einstein’s energy packets came to be seen as “photons”. The electron showed that electric charge was concentrated into point-like particles; the photon was a way of seeing energy as being concentrated in just the same way. Work by Einstein and others showed that the two particles were intimately involved with each other. To get energy into an electron, you have to use a photon; and when an electron is induced to give up energy, the result is a photon. This mutualism is embodied in some of today’s most pervasive technologies; ▶▶



► solar cells, digital cameras, fibre-optic datalinks, LED lighting and lasers. It is used to measure the cosmos and probe the fabric of space and time. It could yet send space probes to the stars.

The settled view of light which provided a context for Einstein's work dated from 1864, when James Clerk Maxwell rolled everything physics knew about electric and magnetic forces into a theory of electromagnetic "fields" produced by objects carrying an electric charge. Stationary charged objects created electric fields; those moving at a constant speed created magnetic fields. Accelerating charged objects created waves composed of both fields at once: electromagnetic radiation. Light was a form of such radiation, Maxwell said. His equations suggested there could be others. In the late 1880s Heinrich Hertz showed that was true by creating radio waves in his laboratory. As well as proving Maxwell right, he added the possibility of wireless telegraphy to the range of electrical technologies—from streetlights to dynamos to transatlantic telegraph cables—that were revolutionising the late 19th century.

Scientists have since detected and/or made use of electromagnetic waves at wavelengths which range from many times the diameter of Earth to a millionth the diameter of an atomic nucleus. The wavelengths of visible light—380 nanometres (billionths of a metre) at the blue end of the spectrum, 700nm at the red end—are special only because they are the ones to which human eyes are sensitive.

The reason Einstein found what he called "Maxwell's brilliant discovery" incomplete was that Maxwell's fields were described, mathematically, as "continuous" functions: the fields' strength had a value at every point in space and could not jump in value from one point to the next. But the material world was not continuous. It was lumpy; its molecules, atoms and electrons were separate entities in space. Physics described the material world through statistical accounts of the behaviour of very large num-

bers of these microscopic lumps; heat, for example, depended on the speed with which they vibrated or bumped into each other. It was a mathematical approach quite unlike Maxwell's treatment of electromagnetic fields.

Yet matter and electromagnetic radiation were intimately associated. Every object emits electromagnetic radiation just by dint of having a temperature; its temperature is a matter of the jiggling of its constituent particles, some of which are charged, and the jiggling of charged particles produces electromagnetic waves. The spread of the wavelengths seen in that radiation—its spectrum—is a function of the body's temperature; the hotter the body, the shorter both the median and highest wavelengths it will emit. The reason the human eye is sensitive to wavelengths in the 380-700nm range is that those are the wavelengths that a body gives off most prolifically if it is heated to 5,500°C, the temperature of the surface of the Sun. They are thus the wavelengths that dominate sunlight (see chart).

If wavelengths and temperature were so intimately involved, Einstein believed, it had to be possible to talk about them in the same mathematical language. So he invented a statistical approach to the way entropy—a tendency towards disorder—varies when the volume of a cavity filled with electromagnetic radiation changes. He then asked, in effect, what sort of lumpiness his statistics might be explaining. The answer was lumps of energy inversely proportional to the wavelength of the light they represented.

In 1905 Einstein was willing to go only so far as suggesting that this light-as-lump point of view provided natural-seeming explanations of various phenomena. Over subsequent years he toughened his stance. His work on relativity showed that Maxwell's luminiferous aether was not required for the propagation of electromagnetic fields; they existed in their own right. His work on light showed that the energy in those fields could be concentrated into the point-like particles in empty space. Light was promoted from what he called "a manifestation of some hypothetical medium" into "an independent entity like matter".

This account was not fully satisfying, because light was now being treated as a continuous wave in some contexts—when being focused by lenses, say—and as something fundamentally lumpy in others. This was resolved by the development of quantum mechanics, in which matter and radiation are both taken to be at the same time particulate and wavy. Part of what it is to be an electron, or a photon, or anything else is to have a "wave function"; the probabilities calculated from these wave functions offer the only access to truth about the particles that physics can have.

Einstein was never reconciled to this. He rejected the idea that a theory which provided only probabilities could be truly fundamental. He wanted a better way for a photon to be both wave and a particle. He never found it. "All these 50 years of conscious brooding", he wrote to a friend in 1951, "have brought me no nearer to the answer to the question, 'What are light quanta?' Nowadays every Tom, Dick and Harry thinks he knows it, but he is mistaken."

Though Einstein was probably not thinking of him specifically, one of those Dicks was Richard Feynman, one of four physicists who, in the late 1940s, finished off the intellectual structure of which Einstein had laid the foundations: a complete theory of light and matter called quantum electrodynamics, or QED. It is a theory in which both matter and radiation are described in terms of fields of a fundamentally quantum nature. Particles—whether of light or matter—are treated as "excited states" of those fields. No phenomenon has been found that QED should be able to explain and cannot; no measurement has been made that does not fit with its predictions.

Feynman was happy to forgo Einstein's brooding and straightforwardly assert that "light is made of particles". His reasoning was pragmatic. All machines made to detect light will, when the light is ►►

It lights rooms, erases tattoos, sculpts corneas and describes the world



### The shape of a hot body's radiation

Light intensity spectrum, by wavelength, watts per square metre per nanometre

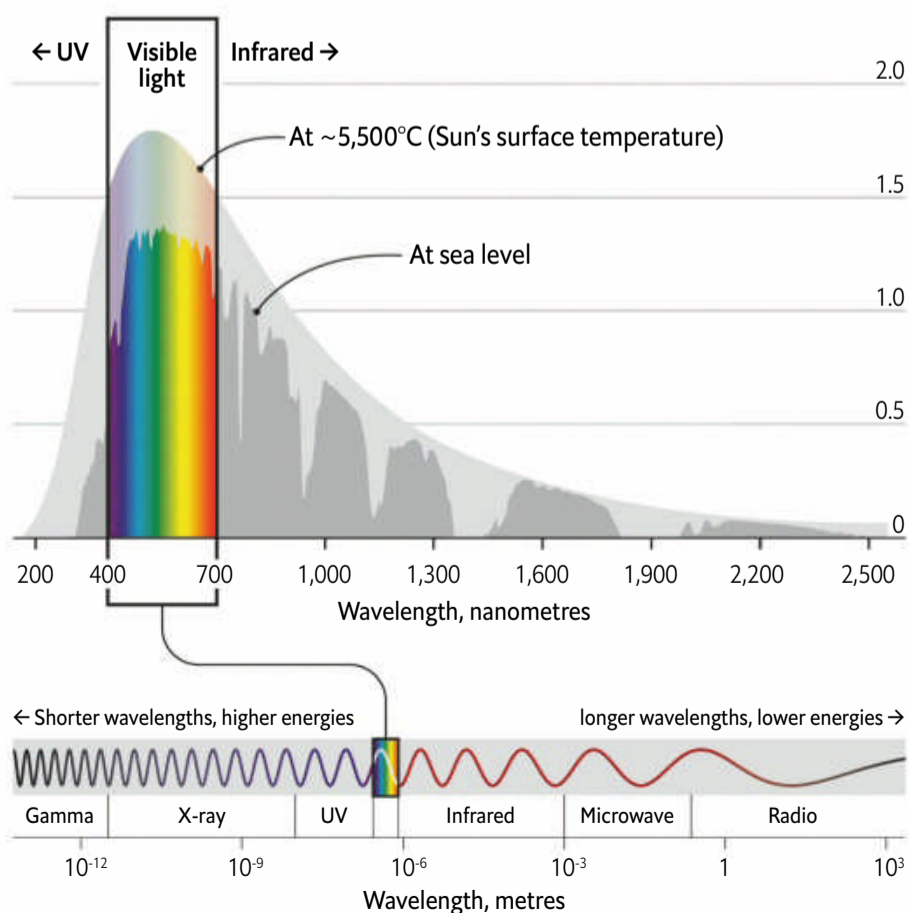



turned down low enough, provide lumpy it's-there-or-it's-not readings rather than continuous ones. The nature of quantum mechanics and its wave functions mean that some of those readings will play havoc with conventional conceptions of what it is for a particle to be in a given place, or to exist as an independent entity. But that is just the way of the quantum, baby.

The precise manipulation of photons has shed much light on “non-locality”, “decoherence” and other strange quantum-mechanical phenomena. It is now making their application to practical problems, through quantum computation and quantum cryptography, increasingly plausible. But this Technology Quarterly is not about such quantum weirdness (for that, see our Technology Quarterly of January 2018). It is about how photons’ interactions with electrons have been used to change the world through the creation of systems that can turn light directly into electricity, and electricity directly into light.

That light and electricity were linked was known long before Einstein. In the 1880s Werner von Siemens, founder of the engineering firm that bears his name, attached “the most far reaching importance” to the mysterious “photoelectric effect” which led panels of selenium to produce trickles of current. Einstein’s theory was taken seriously in part because it explained why a faint short-wavelength light could produce such a current when a bright longer-wavelength light could not: what mattered was the amount of energy in each photon, not the total number of photons.

Technology built on such ideas has since allowed light to be turned into electricity on a scale that would have boggled Siemens’s mind. It lets billions of phone users make digital videos and send them to each other through an infrastructure woven from whiskers of glass. It lights rooms, erases tattoos, sculpts corneas and describes the world to driverless cars. Ingenuity and happy chance, government subsidies and the search for profit have created from Einstein’s suggestion a golden age of light—a burst of innovation that, a century on, is not remotely over. ■

## Solar power

# Gradually, then all at once...

### How government fiat brought about an industrial revolution

**I**N 1954 AT&T’s Bell Labs announced, with some fanfare, a “solar battery”—a device which would supply electricity constantly, with no need for recharging, whenever it was illuminated. At a time when scientific miracles were much in vogue, the *New York Times* thought this gadget front-page news: the conversion of sunlight into electrical power might herald “the realisation of one of mankind’s most cherished dreams—the harnessing of the almost limitless energy of the Sun for the uses of civilisation.”

One could quibble with the idea that industrialising solar power was one of humankind’s most cherished dreams—search for it in Shakespeare and you search in vain—but it had certainly had its enthusiasts. As they were and remain keen to inform all and sundry, sunlight delivers more energy to the Earth in an hour than humankind uses in a year. Until 1954, though, the heliophiles could offer no better way of using that bounty than as an agent for warming water and generating steam—tasks that coal and gas performed much more readily. The solar battery offered instead a direct route to solar power; light went in, current came out. There were no moving parts to wear out or break down; just little sheets of silicon the size of razor blades.

It was this directness that justified the *Times*’s ideas about har-

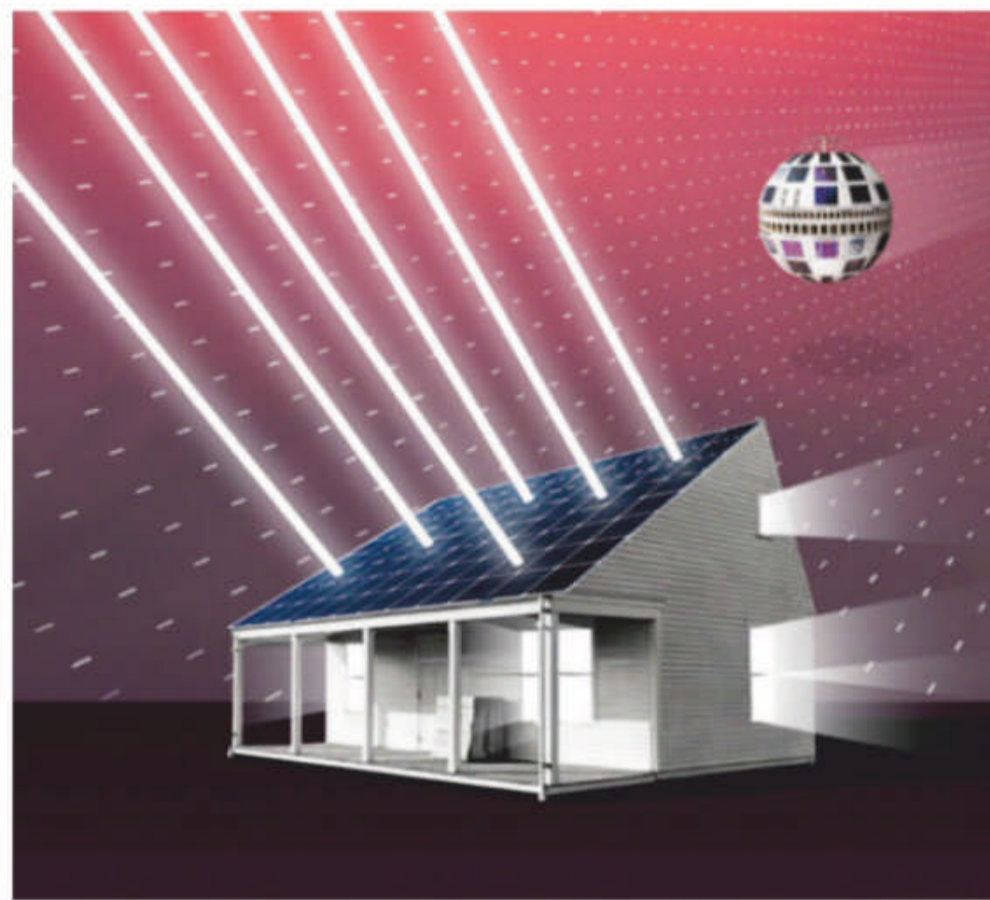

nessing unlimited energy; it was proper journalistic prudence that added the crucial qualifier “eventually”. The adverb cashed out at a bit more than half a century. Solar cells spent 50 years getting cheaper and better in a variety of marginal niches. Then, in the space of little more than a decade, they became both widespread and cheap. In 2020, 132bn watts of new solar generating capacity were installed around the world; in many places solar panels are now by far the cheapest way to produce electricity. This transformation was not brought about by a technological breakthrough in the way that photons arriving from the Sun deliver energy to electrons waiting in the panels. It was the result of a decisive shift in German government policy happening to coincide with China becoming the dominant force in global manufacturing.

The origin of AT&T’s solar battery lay in a discovery made 14 years earlier. On February 23rd 1940 Russell Ohl, a researcher at Bell Labs who bore a distinct resemblance to the actor Wallace Shawn, shone a bright light onto an odd rod of silicon he was investigating. A current immediately began to flow between the electrodes stuck to the rod’s ends. When Ohl put a fan in between the light and the rod the current started oscillating to the shadow-light-shadow-light rhythm of the fan’s eclipsing blades. The rod’s odd electrical behaviour was demonstrably down to the light.

That light could drive currents in some materials had been known since the 19th century; it was one of the things for which Einstein’s paper of 1905 provided a general explanation. What distinguished Ohl’s observation was that at Bell Labs he and his colleagues had the right tools, physical and conceptual, to make sense of how it was happening and how to improve its efficiency.

They discovered that the odd rod contained what came to be called a “p-n junction”—an internal electric field created by two slightly different types of silicon abutting one another. It sounds like a minor defect, but today it is more or less as fundamental to civilisation as the wheel. Applied in the field of electronics, the p-n junction changed AT&T’s world from one of vacuum tubes, physical switches and operators working telephone exchanges to one embodied in slivers of silicon. Configured to make use of light, it is now helping to free the world of the need for fossil fuel.

Making such junctions is a matter of “doping” silicon by adding traces of other elements. Atoms in crystals are tied together by chemical bonds made of shared outer electrons. In a crystal of pure ▶▶



▶ silicon, each atom uses its four outer electrons to make four such bonds to four neighbours. Since electrical conductors depend on free-flowing electrons, pure silicon, with all its electrons tied up, is an electrical insulator.

Dope the silicon with phosphorus and that changes: the insulator becomes a semiconductor. Phosphorus has five outer electrons, compared with silicon's four. When a phosphorous atom finds itself in a silicon lattice, four of those electrons will form bonds with its four silicon neighbours. But the fifth will be free to roam, and thus to conduct current. Doping which adds electrons in this way is known as n-type. For p-type doping you add an atom like boron, which has only three outer electrons. Now the lattice has holes in it. Those holes can also, like spare electrons, move through the lattice carrying current.

By an accident of its manufacture, Ohl's sample had layers of p- and n-type silicon right next to each other. While normally both types of doped silicon would pass some current, in conjunction, surprisingly, they could not—at least, not without light. This was because electrons in the n-type silicon had diffused into the p-type, with holes going the other way. These displaced charge carriers created an electric field, and that electric field formed a barrier no further electrons could pass.

Shine a light on such a junction, though, and the photons will knock loose fresh electrons—which, if in the junction, will flow in response to the electric field. If you put a metal electrode on the surface of the n-type silicon, another on the surface of the p-type silicon, and run a wire between them, the electrons will flow along that wire to the p-type silicon, where they will recombine with holes moving in the opposite direction: behold, a current.

Though its sensitivity to light brought the p-n junction to Ohl's attention, it was not its initial claim to fame. Bell Labs wanted to find a way of replacing the vacuum tubes and other paraphernalia on which AT&T's business depended. The p-n junction proved just the ticket. In 1947 colleagues of Ohl's came up with a device in which the insulating effect of a p-n junction could be manipulated with a second electric field, thus creating an on/off switch: the transistor. Transistors became the basis of new, cheap "solid-state" electronic circuitry. Technology which crammed many of them on to a single piece of semiconductor spawned the silicon chip.

## Up the junction

How a solar cell works

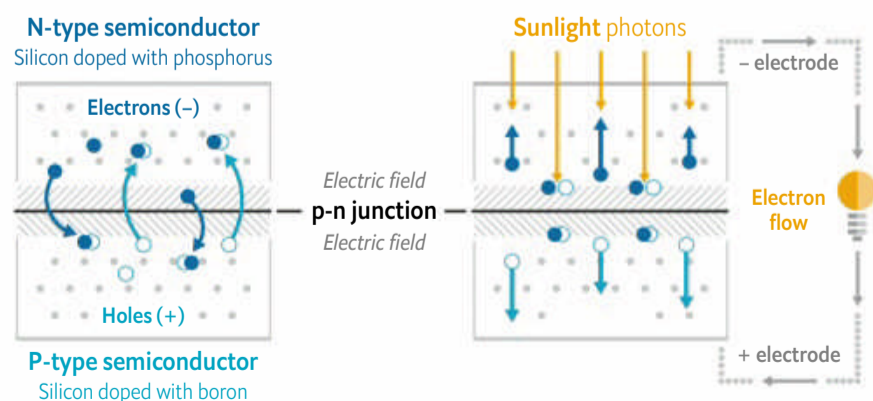

When n- and p-doped semiconductors are brought into contact, charge carriers from each diffuse into the other. This sets up an electric field at the p-n junction.

When light frees electrons and holes near the junction, the field pushes electrons one way and holes the other, causing a current to flow.

## Catch some rays

Solar panel price v capacity  
1976-2020

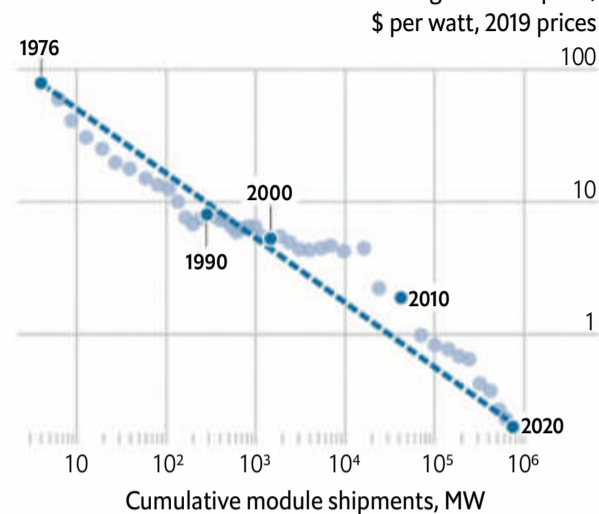

Source: BloombergNEF

Solar cells are made in a similar way to silicon chips but are much less complex. Their junctions just sit there, always on, turning energy from photons into electricity. This was not, at first, a mass-market proposition. In 1954 Bell Labs calculated that using its "photovoltaic" batteries to power an American home would cost \$1.5m. But history shows that, in general, new energy technologies do not compete on price; they flourish by serving a market where there are no other options. For photovoltaics this hang-the-expense, has-to-be-you niche turned out to be in orbit. Demand for power on board satellites drove a lucrative early market for solar cells. In time remote terrestrial locations started to find uses for them, too, and the oil shocks of the 1970s saw governments get interested. An industry rule of thumb held that for every doubling of cumulative production, the unit price dropped by almost 30%—a pretty typical "experience curve". And early on, when installed capacity was low, repeated doubling was feasible even with limited demand.

By 2000 there was almost one gigawatt (1bn watts, or 1GW) of photovoltaic capacity installed worldwide—quite a lot of it on Japanese roofs, courtesy of a subsidy programme aimed at the country's semiconductor industry—and the price per watt was less than a tenth what it had been in the 1970s. It was against this background that the Social Democrats and strongly pro-solar Greens running Germany beefed up a subsidy system previously geared to encouraging solar power on a village-by-village or roof-by-roof basis. As of 2004, installations of any size could sell any amount of solar energy to the grid for €457 (\$567) per megawatt-hour—about five times what it cost to generate electricity from coal at the time. The price was guaranteed for 20 years. The touchpaper was lit.

And the rocket took off. By 2012 Germany had paid out more than €200bn in subsidies. It had also changed the world. Between 2004 and 2010 the global market for solar panels grew 30-fold as investors in Germany and the other countries which followed its lead piled in. Initially, and alarmingly for the exchequers involved, prices did not fall; there were worries that the experience curve had gone flat. But the plateau was an artefact of almost unlimited demand meeting a bottleneck in silicon supply. After Spain's subsidy system collapsed in 2008 solar-panel prices plummeted even as installations continued. By 2012 the price of a panel was a sixth what it had been in 2004, and it has gone on falling ever since. The experience curve may even have steepened (see chart). In sunny places new solar-power installations are significantly cheaper than generating electricity from fossil fuels. Installed capacity is now 776GW, more than 100 times what it was in 2004.

That does not mean Germany got exactly what it wanted. Solar power is not the decentralised, communal source of self-sufficient energy the Greens dreamed of; its provision is dominated by large industrial installations. And the panels on those installations are not made by the German companies the Social Democrats wanted to support: Chinese manufacturers trounced them. But they do provide the world with a zero-carbon energy source cheaper than fossil fuels, and there is room for many more of them. By striking at a time when the state of the art had evolved enough for a massive scale-up to be just about affordable, Germany forced prices down enough for less expansive subsidies elsewhere to ease them down even further, to the point that subsidy was no longer necessary.

It is a striking contrast to the history of nuclear power. Introduced in 1954, like the solar battery, civilian nuclear-power plants were seen as hugely promising. But since the 1970s nuclear experience has grown only slowly, and prices have risen rather than fall. ▶▶



► en. Of the many reasons for this, one is the benefit brought by extended small-scale experimentation. Energy technologies cannot be magicked into being fully formed, as was attempted in the case of nuclear; they need an adolescence. Jenny Chase of Bloomberg-NEF, a data provider, says that in the company's "economic transition" scenario solar starts to deliver more kilowatt-hours than nuclear by 2031. In practice she expects it to pull ahead sooner.

Yet solar's success is of a peculiar sort. The sector's bankruptcies are legion. The German panel manufacturers that went public in 2005 and the Silicon Valley startups generously funded over the following years all fell victim to cheaper silicon and the ambitious, subsidised Chinese manufacturers that now dominate supply. And those firms are hardly huge. The industry boasts no giants comparable to those in aircraft manufacture or pharmaceuticals, let alone computing; no solar company has a market capitalisation of more than \$10bn, and no solar CEO is in danger of being recognised on the street. It is a commodity business in which the commodity's price moves in only one direction and everyone works on very thin margins. Good for the planet—but hardly a gold mine. ■

### Information technology

## Cosmos, meet commerce

### From the universe to the dataverse, all by light

AMERICA'S BIGGEST spread of silicon for turning photons into power sits in the Mojave desert about 100km north of downtown Los Angeles. The Solar Star facility consists of 1.7m solar modules on 13 square kilometres of land. On sunny days it can feed more than half a gigawatt into the grid. In a nice inversion of the old solar-booster's saw that the Sun provides enough energy in an hour to power civilisation for a year, Solar Star provides enough energy in a year to power civilisation for about an hour.

Such installations are changing the world. Other photon-driven technologies, those concerned with the gathering and transmission of information, have already done so.

Five-and-a-half hours' drive north-west from Solar Star, at a national laboratory in Silicon Valley called SLAC, you can find the world's biggest spread of silicon for turning photons into information. It consists of 189 specialised chips arranged in a disk about 64cm across which will occupy the focal plane of the world's largest digital camera. Over ten years it will produce a database in which the positions and behaviours of hundreds of billions of celestial objects will be stored.

This array is remarkable in various ways, including its size, the fidelity of its electronics and the precision of its alignment. But in its essence is not that different from the heart of a 1980s camcorder. Just as it is possible to produce a chip with millions of transistors on it, it is possible to produce a chip with millions of photon receivers on it. Fitted with the right lenses and mirrors, such chips can take pictures.

Later this year the array now at SLAC will be shipped to the Vera C. Rubin Observatory, a new facility in the Chilean Andes named after an American astronomer who pioneered research into "dark matter". There light from distant galaxies will bounce off the three mirrors of the observatory's telescope and pass through three huge camera lenses so as to form a pin-sharp image on the array's perfectly flat 189-chip surface. On each of those chips sit 16m "charge-coupled devices" (CCDs), each containing a p-n junction where incoming photons can knock loose electrons. Each time a far-flung photon does so, the liberated electron is stored in a tiny capacitor.

During the 15 seconds of a typical exposure some of these capacitors will store dozens of electrons. Some will store none.

At the end of the exposure, each of the array's 3.2bn CCDs will pass its electrons on to the element next door like a string of emergency workers passing sandbags. Circuits at the end of the sandbag line will count the electrons from each element, and use their number to establish the brightness of the corresponding pixel in the resultant 3.2 gigapixel image. These images will contain 50 times more data than those produced by the best digital cameras used in cinema. They will capture patches of sky 40 times the apparent size of the Moon at a level of detail that would pick out a golf ball 25km away; the faintest of the millions of things seen in each frame will be 25m times fainter than the dimmest stars that can be seen with the naked eye.

But single frames are not enough. The telescope will scan the whole sky every few days for a decade, producing hundreds of images of every part of it. Comparing each new image with its predecessors will reveal celestial change: bodies moving, brightening, vanishing. Unusual changes will need to be swiftly followed up to see if they reveal something fundamentally new, which means data must be got off the mountain as fast as possible. That will be done with photon-based technology as remarkable, in its way, as the CCD array—but as ubiquitous as the great camera is unique.

The information that comes into the observatory as a drizzle of photons from the far reaches of the universe will leave it encoded on a stream of photons pulsing down an optical fibre. A Chilean outfit which provides connectivity for science and education, REUNA, gets the data from the observatory to Santiago. Another data-service provider, Ampath, provides a link to Miami using either an undersea cable in the Pacific or one in the Atlantic, depending on traffic. From Miami the data flash to SLAC. If the software which checks for changes sees something exciting the world will receive breaking news from the most distant of elsewhere less than a minute after the relevant photons arrived at the camera.

And while en route to and from California, the data will be surrounded within optical fibres by vastly more, vastly more mundane data travelling from person to person or from device to cloud. ►►





► In terms of astronomy the Rubin observatory's 60,000 terabyte database will be the biggest thing ever. In terms of the data that today's world produces and moves around it is a drop in the ocean.

Optical-fibre networks are the backbones of every national telecoms system; they connect six of the seven continents to each other and link the phone masts which serve billions of smartphones to the clouds where their data can be processed and stored. Big data can only be usefully big because these narrow highways provide so much data-transfer capacity.

### Through a glass, brightly

The light which goes into those fibres is made in semiconductors. There are various sorts of device which can reverse what goes on in a photovoltaic cell, turning current into light by means of a p-n junction, though typically in a mixture of gallium and arsenic, rather than in silicon. The simplest, light-emitting diodes (LEDs), are increasingly used to illuminate the screens of televisions, computers and phones, as well as the rooms in which people use those devices. LEDs' ability to make light without heat—unlike a star or an incandescent bulb—makes them much more efficient than a light based on a hot filament can be, and also much longer lasting. They have thus continued the trend, first discerned by William Nordhaus, an economist, for ever less of the cost of living to be spent on light, a significant and absolute gain in human welfare delivered through wave after wave of innovation.

The light used in optical fibres mostly comes not from LEDs but from semiconductor lasers (of which more in the next chapter) that are built a bit differently; they squirt their light out along the plane of the p-n junction, which is to say out of the side of the chip. At the far end this light is met by a photodiode—a device like a CCD, but in which the electrons knocked free by the incoming photons are processed immediately rather than stored. Between them is a thread of glass of staggering transparency.

When researchers began to wonder, in the 1960s, whether light shone through glass fibres could be used for communications the idea seemed more than quixotic. Even a thin layer of glass absorbs a fair amount of the light which passes through it; just half a centimetre of plate glass reduces brightness by 20%. The most transparent glass in the world, that used in endoscopes, was 200 times better—you could pass a light beam through a metre of it and only lose 20%. But that still meant that, over 20 metres, 99% of the light would be absorbed. If you fed all the photons with which the Sun provides the Earth into one end of such a fibre, every single one of them would be absorbed before they had travelled a kilometre (and the fibre would have vapourised, but that's another problem).

The one thing that the fibre aficionados had on their side was that no one had ever really tried to push the absorption barrier in glass, because glass rarely needed to be more than a couple of centimetres thick. Given good reason to try, what had seemed impossible was quite quickly achieved. In 1965 Charles Kao, a researcher at STL, a British telecoms company, set the bar for practical communication at a loss of 99% of the incoming light over a kilometre of glass: that is, performance 50 times better than endoscope glass. Within five years a researcher at Corning Glass, Donald Keck, had cleared that bar with a fibre which lost only 96% of light over a kilometre.

The development was not exactly smooth. As well as technical hurdles there were cultural differences—telecoms researchers, mainly electronic engineers, did not understand glass, and glassmakers did not understand electronics. Though in ret-

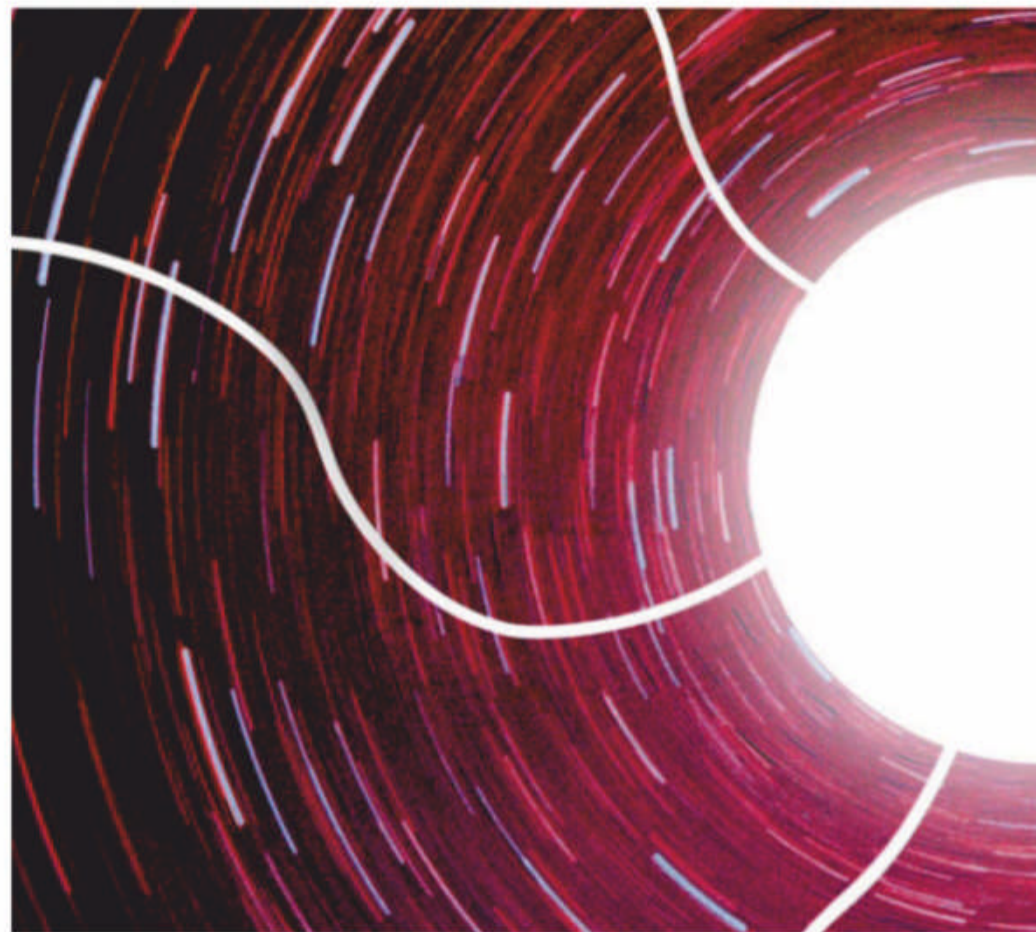

rospect the technology's promise seems obvious, many in telecoms remained convinced that microwaves guided by metal tubing were the future of high-data-rate communications; Bell Labs sidelined its optical-fibre team for years. The economic downturn of the 1970s hit corporate investment plans.

But by the early 1980s the technology was becoming good enough to compete with microwaves beamed from antenna to antenna. And in 1982 the break-up of AT&T created a competitive market for long-distance telephony in America. The newcomers, with no legacy technology, went for optical fibres. In the mid-1980s a team at the University of Southampton developed optical amplifiers: stretches of fibre doped with erbium, a rare-earth element. If you pump energy into the erbium atoms through the side of the fibre, they will produce new photons when hit by those coming down the length of the fibre, boosting the signal. Such amplifiers made it possible to create optical fibre cables that could cross oceans. The first, TAT-8, was laid in 1988. Its 280 megabit-per-second (Mbps) capacity was ten times that of the previous link, which passed radio waves along coaxial cable. Some thought it would take a decade for the cable to fill up; it reached full capacity in just 18 months.

Part of that capacity was a dedicated 1.5Mbps link between CERN, a European particle-physics lab, and Cornell University in upstate New York, one of the hubs of NSFnet, the scientific network which was then the backbone of the internet. That link made it possible for Tim Berners-Lee, a researcher at CERN, to demonstrate his ideas about "browsers" and "HTML" to American colleagues. TAT-8 put the "worldwide" into the world wide web.

From then on, optical-fibre capacity and the internet grew hand in hand. As computers have improved, fibre capacity has kept up. It follows what Jeff Hecht, the doyen of laser journalists, calls Keck's law, after Donald Keck (see chart).

### This is the end

Moore's law v Keck's law, log scale

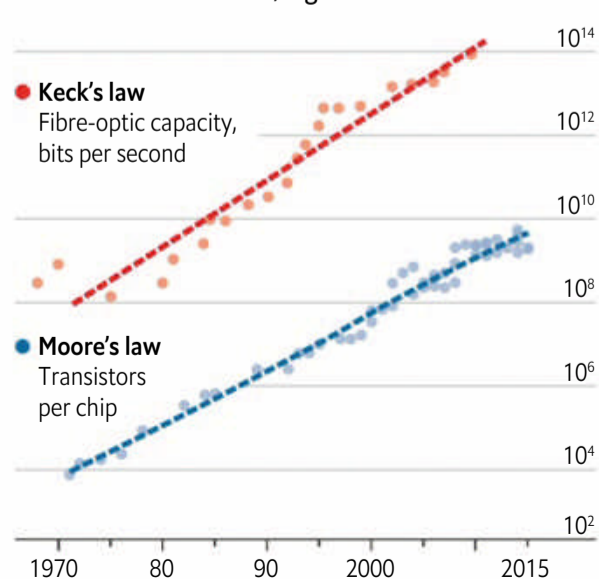

Sources: Intel; Donald Keck





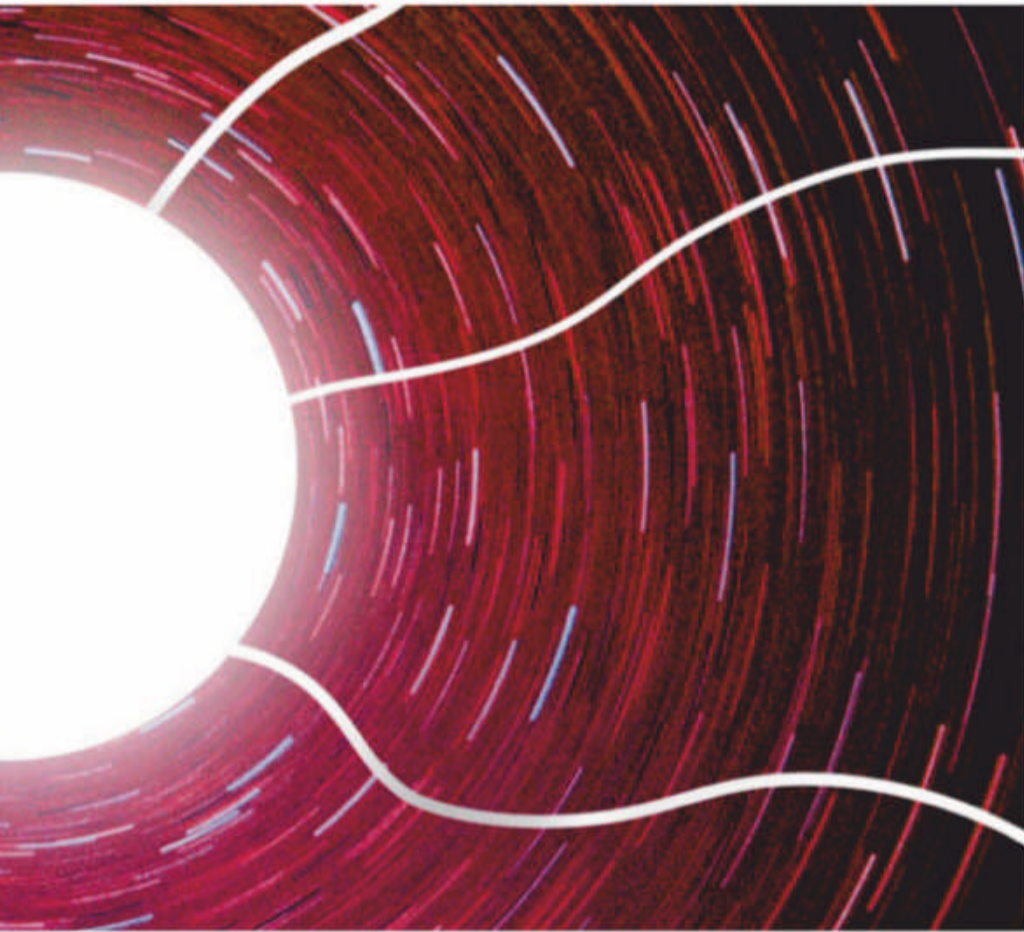

could nullify a nuclear attack. This time round, though, there was no need to make up a new name for the sort of ray guns required. They would be lasers. Continuing the mixing of real life with science fiction, the programme was promptly dubbed “Star Wars”.

The idea that lasers might make awesome weapons has dogged the devices’ history. When the inventor of the first working laser, Theodore Maiman, described to a press conference in 1960 the properties of its wondrous light—its extraordinary capacity for brightness, its purity of wavelength, its production of light independent of heat—he stressed its potential for all sorts of applications: communications first and foremost, but also chemistry, medicine and remote sensing. According to Jeff Hecht’s book “Lasers, Death Rays and the Long, Strange Quest for the Ultimate Weapon” Maiman was deeply disappointed, on returning home, to find the media coverage concentrated on its potential as a weapon.

### They do it with mirrors

It was not just because he was working for a defence contractor, Hughes Aircraft, at the time that Maiman should have known better. The appeal of instantaneous and deadly action along the line of sight is obvious to anyone who has ever looked daggers at an adversary; it has been the stuff of myth since Medusa. By the 20th century the notion underlying that nightmare—that vision is a matter of rays emanating from the eyes, rather than of light from elsewhere bouncing into the eyes—had long been abandoned. But the idea that the previously fantastical could be realised through technology had become quite commonplace; witness the space rockets and atomic superweapons that had made their way out of H.G. Wells and into the daily papers. When the laser came along it seemed obvious that it would be the basis of ray guns like those wielded by the Martians in Wells’s “The War of the Worlds” (1898).

The basic principles of the laser, like the idea of the photon, go back to Albert Einstein. In 1916, after producing his general theory of relativity, Einstein returned to the inter-relatedness of matter and radiation. In this new analysis he showed that the idea that energy in a system could only vary in steps, rather than smoothly (a key part of quantum physics) could explain why the spectrum of a hot body had to have the distinctive shape that it did. The work had an interesting unlooked-for implication: when an electron occupied a raised energy level in an atom it was possible for a passing photon of the right frequency to knock it down to a lower level without itself being absorbed. The energy thus released would take the form of a second photon identical to the first.

This is the process that allows erbium amplifiers to boost the signals on long-haul optical fibres like those that cross the oceans. Energy is pumped into the electrons of the erbium atoms from outside; as photons pass through they knock those electrons down, thereby producing further photons. A laser differs from such an amplifier in the addition of mirrors that allow ever more photons to pass back and forth through the amplifying medium.

When released from this amplifying cavity these photons produce a beam which is not just of a single wavelength (because all the photons have the same energy) but which is also coherent: the light’s waves and troughs all line up. It is this purity of wavelength and phase which allows the laser to be used so precisely. It can be easily focused into a point for welding, cutting or sintering; it can form a barely spreading beam for scanning. Even in bright sunlight, reflected laser light can be quite easily picked up by a sensor on the lookout for it.

Laser light is thus distinctive. Lasers themselves are many and various. The medium containing the electrons that are to be pumped up with energy can be a crystal (Maiman’s original device used a synthetic ruby), a gas (carbon-dioxide lasers have long been popular for industrial uses), glass or a semiconductor such as gallium arsenide. The energy used for the pumping can be provided by electrical discharges, flashlamps, chemical reactions or, in semiconductors, currents. ▶

▶ The innovation is mostly at the ends of the fibres, rather than in the fibre itself. The Rubin observatory’s brand new system uses equipment from Infinera, an American company, which allows many different lasers with slightly different wavelengths to share the same fibre; “dense wave-division multiplexing” of this sort can now allow up to 80 wavelengths to be used at a time. Once content to send information in “symbols” of just one bit—dim the laser for 1, brighten it for 0—engineers now use systems in which the phase of the laser’s light (the rise and fall of its peaks and troughs) encodes information, too. Single symbols can now carry two or four bits of information, rather than just one.

The latest transatlantic cable, Dunant, commissioned in 2020, contains 24 fibres and uses such tricks to carry 300 terabits per second—more than a million times what TAT-8 could cope with. It was paid for not by a phone company, but by Google, and the tech giant plans to lay another in just two years’ time. This is how information, whether from TikTok or a distant galaxy, girdles the Earth. ■

## Lasers

# Outshining the sun

**It has failed to live up to its perceived military potential, but the laser’s peaceable applications have been spectacular**

THE MCGUFFIN in the 1940 Warner Brothers B-movie “Murder in the Air” was an “Inertia projector”—a new name for a device, the ray gun, already established as a science-fiction staple. As a helpful admiral explains, this particular ray gun “not only makes the United States invincible in war, but in so doing promises to become the greatest force for world peace ever discovered”.

In 1983 the actor who starred in that film as secret agent “Brass” Bancroft, Ronald Reagan, echoed the admiral’s conflation of an indomitable America with world peace in a presidential address which called on the country’s scientists to create weapons that





diode is turned into a numeric code that can be used by a computer to look up the relevant product data.

As computer vision improves, the bar code's role as a source of information may diminish in importance, just as has that of CDs—also read by laser. But lasers are not limited to reading information deliberately built into or imprinted on things. They can also read the world at large.

Using laser light in the same way that sonar uses sound and radar uses radio waves, “lidar” technology is used to build digital models of all sorts of environments. Ecologists use it to estimate forest biomass, film-makers to produce simulacra of famous cities that can then be trashed in spectacular computer-generated mayhem. Would-be-autonomous vehicles use lidar to spot obstacles. If your phone recognises your face in the dark, it is because it is running its gentle infrared lidar across your features. Thanks to their precision, lasers can pick up movement, too. Some lidars measure wind speeds by tracking dust motes in the air. Spies use lasers reflected from windows to snoop on conversations; the tiny vibrations in the glass caused by voices on the other side create measurable variations in the wavelength of the reflected light.

There is no grand sweep to laser development akin to Moore's law for chips or Keck's law for optical communications. Different types of laser improve according to different measures and at different rates. But there are two recent trends which promise greater power. One is the two-stage laser. Semiconductor lasers can be used to pump energy into the crystals or glasses used by other lasers in a way that minimises the production of waste heat—always the bane of high-powered lasers. The latest military lasers, designed for last-ditch defence against incoming anti-ship and anti-tank missiles, use this sort of laser-on-laser action to produce continuous beams with powers in the tens of kilowatts. The possibility of upping those tens to hundreds or thousands is more plausible than any previous vision of the laser as a weapon of war.

The other development is the vertical-cavity surface-emitting laser, or VCSEL—a semiconductor laser in which the beam comes out of the top of the chip, rather than the edge. That geometry makes it possible to put a lot of them on to the surface of a chip, as is done with transistors in microchips and detectors in cameras. Such laser arrays have been around for decades, but in the past few years they have been getting more powerful and capable. The lidars wanted by carmakers are tumbling in price. VCSELS can also be used to project images onto surfaces—including, in experimental settings, directly onto the retina in the back of the eye.

The technology does not have to be that gentle. Imagine replacing the 3.2bn-CCD array that will produce images at the Rubin observatory with a 3.2bn-VCSEL array: the telescope would send a multi-megawatt searchlight into the heavens. This is not in itself a practical suggestion—but it speaks to a possible technological trajectory. When things become miniaturised, parallelised and produced in semiconductor foundries, progress can become very fast. Where once there were mainframes, now there are iPhones. And the VCSEL, like the transistor and the CCD before it, has become such a technology.

Phil Lubin, a professor at the University of California, Santa Barbara, sees really powerful laser arrays as tools for spaceflight. Although photons have no mass, they do have momentum; bounce them off a mirror and the mirror recoils. This effect is tiny beyond the telling of it, but if you hit a mirror with photons in ludicrous abundance you can start to exert real force. Beams in the tens of gigawatts could fill the mirror-sails of tiny spacecraft, blowing them swiftly across the solar system—or even sending them on their way to other stars.

It is all utterly fantastical. But, as Dr Lubin points out, no more so than an iPhone would have seemed, if described 50 years ago. The fantastical should not be confused with the impossible. ■

▶ Consistently bewitched by the possibility of ray guns, the Pentagon paid for the lion's share of research into all sorts of lasers in the technology's early years, and in subsequent decades spent billions more on the beasts it saw as most promising. But none provided the zapping power needed to render nuclear weapons “impotent and obsolete”, as Reagan requested. The technologically plausible if rebarbative option of designing less powerful laser weapons that would blind enemy soldiers en masse was pre-emptively outlawed by international convention.

But the laser still revolutionised military affairs, not through sheer power, but through its capacity for exactitude. By the 1970s the US Air Force was using lasers to illuminate targets so that bombs given the capability to discern the relevant wavelengths would home in on them, ushering in an age of “precision bombing”. Not all of the smart weapons that can now be relied on to hit an arbitrarily designated target are laser-guided. But it was the laser which proved such things were possible.

Rather than serving as a means of destruction, beyond the battlefield the laser has instead become a tool of production, allowing both precise measurement and the perfectly calibrated application of power. In factories and workshops around the world it cuts and welds, engraves and drills, probes, peens and polishes. In 3D manufacturing it melts, fuses and sinters metal and plastic powders into precisely defined shapes. In surgeries it incises, excises and cauterises; in offices it prints and prints and prints.

The laser is not content to change the world; it also seeks to interpret it. Though the foundational role of lasers in the information economy has been to transfer data down optical fibres (see previous story), they are also used as active sensors with which to gather data in the first place. Some of the information that lasers read from the world has been put there for that purpose—printed on a bar code, for example. When one is illuminated by a laser, the pattern of reflection and absorption recorded by a watching photo-

**It cuts and welds,  
engraves and drills,  
probes, peens and  
polishes**





## Advancing science

## New enlightenments

From making living lasers to detecting black holes, the needs of science drive the technologies of light to extremes

ALL THE technologies discussed in this report are moving forward apace. The companies which provide machinery to solar-cell manufacturers are ceaselessly trying to make more efficient use of silicon and less costly modules. In universities and elsewhere researchers are looking at ways to add a second layer to such cells so as to capture energy at wavelengths silicon ignores—though their best attempts so far do not last very long outdoors.

Advances in manufacturing and design are making LEDs ever better sources of illumination. In more and more screens they backlight the liquid-crystal shutters which brighten pixels by detenebration. Some screens already do without shuttering, using liquid-crystal-free arrays of micro-LEDs to produce images that offer better contrast and use less energy. In information technology the division of labour that sees data processing done by electrons and data transmission by photons is under attack; switches that could be programmed to do some information processing while keeping that information in the form of photons would allow data to flow around data centres more quickly and efficiently. Laser beams of slightly different wavelengths are being packed ever more densely into optical fibres, with more bits encoded into every symbol stamped on to their light. The current record for data transfer down a single fibre, held by researchers at UCL, a British university, is 178 terabits a second.

But if you want to see lasers which push the boundaries of the possible in the most dramatic of ways, you have to turn to those made, not for practical applications, but to further science. Wherever researchers require ludicrous amounts of power or precision, there's every chance that they are using a laser, some sort of digital photon detector, or both. To see the cutting edge of what light can do, head for a lab.

The National Ignition Facility (NIF) at Lawrence Livermore National Laboratory in California is a case in point: walking its halls evokes a sense of the technological sublime which is all but visceral. The 192 laser beams from the 100-metre-long, xenon-pumped beamlines that fill its two warehouse-sized clean rooms converge on a peculiarly perforated spherical chamber. When NIF is operational a tiny bubble at the centre of that chamber is illuminated with 500 terawatts, which is to say 500,000GW.

Given that the world's total electricity generating capacity is less than 5TW, how is a 500TW system possible? The answer is brevity. Because power is energy divided by time, a relatively small amount of energy can provide a huge amount of power if it is delivered quickly enough. The NIF fires for only a few tens of nanoseconds (billionths of a second) at a time. Each blink-and-you-miss-it 500TW blast thus delivers only a kilowatt-hour or so of energy.

Using such a gargantuan device to provide such a modest amount of energy seems bizarre. But NIF's job requires the energy to be delivered with great spatial precision and almost instantaneously. Only then can it heat the laser's tiny targets to temperatures and pressures otherwise reached only in the centres of stars and the blasts of nuclear weapons—conditions which can fuse atomic nuclei. Congress paid billions for the NIF on the basis that it might open the way to making nuclear fusion of this sort a practical energy source. It has not delivered on those dreams. But it has provided new insights into astrophysics as well as experimental data relevant to the design and maintenance of hydrogen bombs, which is Lawrence Livermore's main concern.

Physicists are not the only scientists entranced by lasers. One of the workhorses of genetic engineering is green fluorescent protein (GFP). The instructions for making GFP are easily added to genes for other proteins. When poked with finely focused lasers these modified proteins fluoresce, thus revealing their whereabouts—a handy way of learning which proteins cells put where.

A remarkable refinement of this technique, first demonstrated in 2011, is to turn the cell itself into a laser. Engineer a cell to produce GFP, put it between two mirrors and pump energy in and the protein's light will be amplified in just the same way as it would in a piece of ruby or neodymium-doped glass. "Light-emission microscopy" based on this possibility amplifies the light given off by fluorescent proteins and other light-emitting markers.

Photons can also be used to change how cells behave. By engineering proteins to be sensitive to light and then turning that light on and off, researchers can change what cells do—including the ways they do, or don't, transmit nerve impulses. Laser light flashed on to the nerves of a suitably engineered flatworm, or shone down optical fibres into the brain of a mouse, allows researchers to turn different parts of the nervous system on and off and observe the changes in behaviour that follow. This "optogenetic" puppeteering provides all sorts of new insights into the machinery of the brain. With all due respect to those using photons to explore the strange interconnectedness of things in quantum mechanics—which Einstein famously described as "spooky"—photons that can literally change a mind in mid-thought may be the spookiest of all.

The degree to which light-based techniques are changing sciences across the board can be seen in the past decade's decisions by the Nobel Physics Committee. In 2014 the committee recognised a physical breakthrough in the production of light—the development of blue LEDs, a technical tour de force which made the production of white light cheaper and easier than ever before. Since then the physics prize has been awarded to three different ways of using lasers either for experiments in the lab or observations of the world. A tour of these prize-winning accomplishments allows a last celebration of this golden age of light.

Start with pure power. A technique called chirped-pulse amplification, developed by Donna Strickland and Gérard Mourou when they were both at the University of Rochester, allows lasers far more powerful than the NIF—lasers which work in the petawatt range. It provides a way around the unfortunate fact that, above a ▶▶

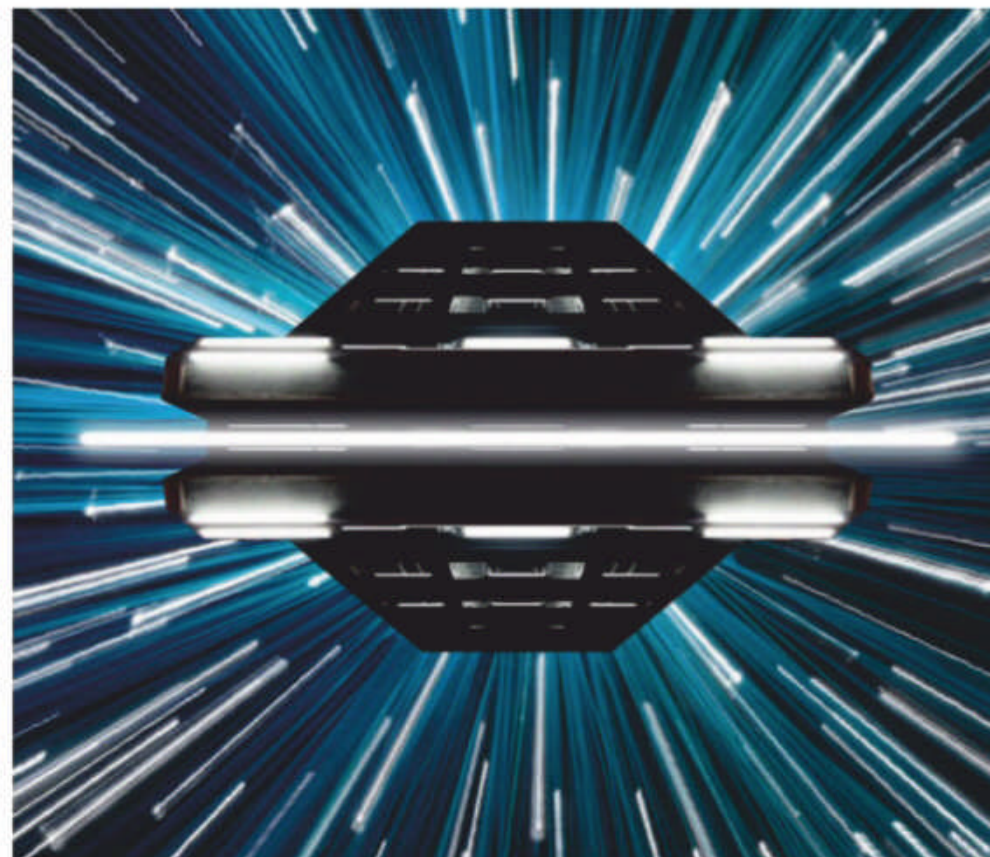



## Where you go, LIGO

How a Laser-Interferometer Gravitational-wave Observatory (LIGO) works

### Before the wave

The light source sends out a beam **1** that is divided by a beam splitter **2**. The beams produced follow paths of identical length **3**, reflecting off mirrors to recombine exactly out of phase **4**, cancelling each other out.

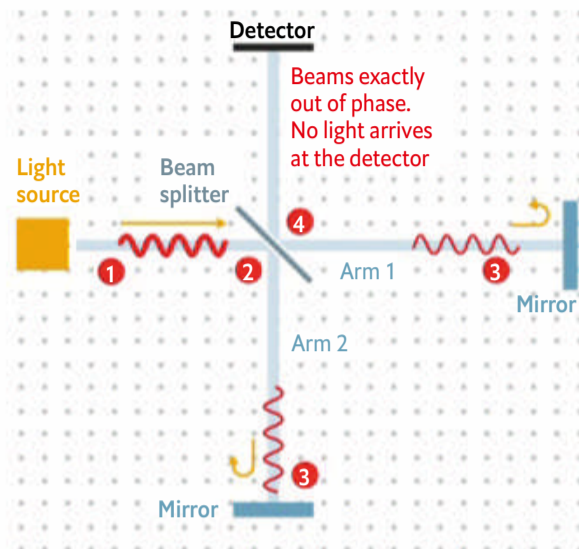

### During the wave

When a gravitational wave arrives, it disturbs spacetime, changing the length of the path along one or both arms (here, arm 2). When the beams recombine and arrive at the detector, they are no longer out of phase.

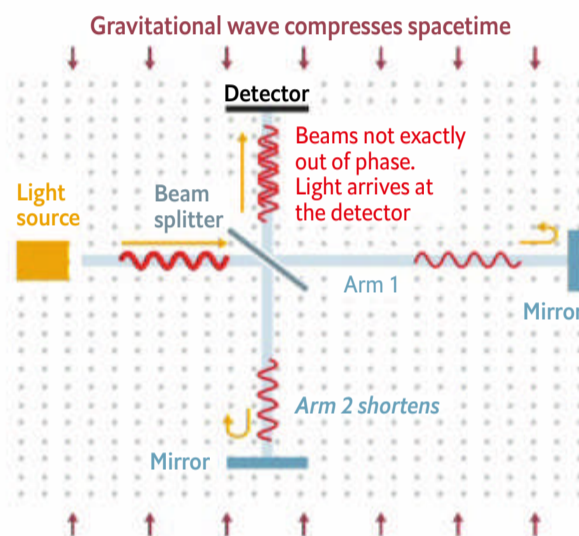

► certain power level, even a very short pulse will melt any laser trying to amplify it further. Chirp amplification solves the problem by stretching pulses out in both space and time. An intense packet of photons that is, say, a millimetre long, and thus passes through any machine in just three trillionths of a second, can be chirped into one that is a metre long and lasts a full three billionths of a second. This stretched pulse is low-power enough to be amplified, after which it can be compressed back into its original form as a burst just as short as ever but now containing many more photons.

Labs around the world now use this technique to produce bursts of light both far shorter and far more powerful than those at NIF using much cheaper equipment. This allows them to study nuclear processes that are even more extreme than fusion. If the pulses can be made 1,000 times shorter still—which Dr Mourou, at least, thinks is possible, given a decade or so—they could achieve something no other technology has yet managed: the creation of matter (and antimatter) from scratch.

Einstein's work dispensed with the need for an all-pervading luminiferous aether. But the fields evoked by quantum electrodynamics (QED), the mid-20th-century culmination of work on electromagnetism, quantum theory and relativity, populate empty space with something else instead: very faint possibilities. And QED says that, if light gets sufficiently intense, its photons will interact with these possibilities to bring forth brand new electrons from empty space. Einstein's insight that mass can be converted into energy has been proven many times, most terribly in nuclear weapons. Creating material particles from massless light alone would be a remarkable turning of the tables, and one that ought to provide new insight into the quantum fields involved.

After power, pressure. The momentum of photons is tiny; but

when applied to tiny things it can do useful work. In the 1960s Arthur Ashkin of Bell Labs realised that, if a small transparent object is placed on the edge of a laser beam it will move to the beam's centre (provided that the beam is brighter at the centre than the edge). This is because the photons that pass through the object have their path bent outward, away from the beam: conservation of momentum requires the object thus diverting them to move in the opposite direction. If, once caught up in the beam, the object strays from its bright centre, the light pressure will bring it back.

In the 1970s Dr Ashkin put this idea into practice, using laser beams as "optical tweezers" with which to manipulate microscopic beads. In the 1980s he got the technique to work on individual bacteria and virus particles, while his student Steven Chu used a variant to trap individual atoms—work that won Dr Chu and colleagues a Nobel prize in 1997. The increasing use made of his tweezers in biology saw Dr Ashkin follow in his student's footsteps in 2018, sharing the prize with Dr Strickland and Dr Mourou.

And then there is precision. Einstein's general theory of relativity, promulgated in 1915, explains gravity in terms of the distortions masses impose on spacetime—spacetime being, to Einstein, simply the thing that clocks and rulers measure. His special theory of relativity had laid out the case for light being the ultimate ruler, a view that measurement professionals now share; the General Conference on Weights and Measures defines the metre not as the length of a specific rod in a vault in Paris, as it once did, but as the distance a photon in a vacuum travels in  $1/299,792,458$  of a second. Thus if you want to see ripples in spacetime—such as those which relativity says must be produced when two very large masses pirouette around each other—light is the best sort of ruler to use.

The Laser Interferometer Gravitational-wave Observatory (LIGO) consists of two such rulers. Its twin detectors, one in Louisiana and one in Washington state, both feature 4km-long perpendicular arms along which laser beams of truly phenomenal stability bounce back and forth (see chart). Instruments mounted at the point where the beams cross compare their phases in order to detect transitory differences in the arms' lengths. Their precision is equivalent to that which would be needed to detect a hair's-breadth change in the distance to a nearby star.

On September 14th 2015 LIGO picked up the shiver in spacetime produced by the merger of two black holes 1.3bn light-years away. In 2017 the Nobel Physics Committee, free of naysaying ophthalmologists, awarded the prize to Rainer Weiss, Kip Thorne and Barry C. Barish, the three scientists who had done most to make that observation happen.

Their extraordinary measurement was treated, quite rightly, as a slightly late 100th-birthday present for Einstein's truly remarkable intellectual achievement. It was also an extraordinary demonstration of what can be done with photons. A century of work by scientists and engineers has taken the energy packets that Einstein first imagined in 1905 and produced a range of technologies with capabilities little short of the miraculous—a collective achievement far greater than any single act of genius. Relativity is remarkable. Putting photons to use has been revolutionary. ■

**ACKNOWLEDGMENTS** A list of acknowledgments and sources is included in the online version of this Technology Quarterly

**OFFER TO READERS** Reprints of this TQ are available, with a minimum order of five copies. For academic institutions the minimum order is 50 and for companies 100. We also offer a customisation service. To order, contact Foster Printing Service: Tel: +1 866 879 9144; email: [economist@fosterprinting.com](mailto:economist@fosterprinting.com)

For information on reusing the articles featured in this TQ, or for copyright queries, contact The Economist Rights and Syndication Department: Tel: +44 (0)20 7576 8000; email: [rights@economist.com](mailto:rights@economist.com)

**MORE TECHNOLOGY QUARTERLIES** Previous TQs can be found at [www.economist.com/technology-quarterly](http://www.economist.com/technology-quarterly)





## Transatlantic relations

## Putting it back together again

BERLIN

## Repairing the transatlantic rift will be a long and tricky business

TWO YEARS ago at the Munich Security Conference, an annual gabfest for buffs of geopolitics, Vice-President Mike Pence delivered to his largely European audience a stinging address, full of rebukes and America First swagger. On the same stage a few hours later, Joe Biden offered a glimpse of a brighter future. “This too shall pass. We will be back,” he said. The election in November seemed to fulfil his prophecy. President-elect Biden has vowed to restore the alliances damaged by Donald Trump. He has stuffed his incoming administration with familiar faces from the Obama years. As he prepares to take office on January 20th, Europeans are again daring to dream.

They are also drawing up to-do lists. A month after Mr Biden’s win the European Commission issued a detailed set of proposals for joint transatlantic action. A source close to the Biden team says it has “substantial alignment with our thinking”. That augurs well for what ought to be a formidable pairing. America and the Euro-

pean Union account for over 40% of the world’s GDP; with Britain, nearly half of its defence spending; and huge regulatory and technological clout. But global challenges are growing and America faces fresh demands on its attention at home and in other parts of the world. Optimists say this bolsters the case for transatlanticism. But to stay relevant, the alliance needs renewal.

Under the Biden administration, transatlantic relations will fall into three baskets. First are the relatively easy wins. Start with the simple fact that Mr Biden is not Mr

Trump. The outgoing president characterised the EU as a “foe” created to impoverish America, and used to dismiss NATO as obsolete. Mr Biden will rejoin the Paris climate agreement and revoke Mr Trump’s withdrawal from the World Health Organisation. A drawdown of troops stationed in Germany, announced last year, is unlikely to stand, and Mr Biden could lift Mr Trump’s tariffs on EU steel and aluminium. Europeans may find America keener to help reform the atrophied World Trade Organisation (WTO), and to resolve a long-running row over aerospace subsidies.

On security Europeans can expect a loud reaffirmation of America’s commitment to Article 5, NATO’s mutual-defence guarantee, and more predictability in its policy towards Russia. Mr Biden has said he will seek to extend New START, a nuclear arms-control agreement with Russia due to expire on February 5th. The EU, with Britain, would also like to see America rejoin the deal they helped negotiate on Iran’s nuclear activity. Mr Biden has indicated a willingness to do so, if Iran complies with its terms. All sides are engaged in a complex diplomatic dance to increase leverage before negotiations start.

More ambitious ideas make up a second basket. Mr Biden has pledged a “summit of democracies” to face off against autocracies. Rather than a blockbuster event, this may look more like a set of principles to ▶▶

## → Also in this section

42 Spain’s fractious government

43 Gibraltar, Britain and Spain

44 Laptop learning in Greece

44 The Dutch monarchy under fire

45 Charlemagne: The clown ceiling



▶ guide policy across a range of issues, capped with a low-key meeting at the end of this year. But corrupt European governments, both in and outside the EU, can expect a rougher ride. On climate the two sides may struggle to get beyond bromides. Co-ordination on carbon pricing will face high hurdles in Congress. European plans for a tax on climate-unfriendly imports risk American cries of protectionism.

Some German politicians hope to revive the Transatlantic Trade and Investment Partnership, an ill-fated Obama-era negotiation. Yet public attitudes on big trade deals have soured on both sides of the Atlantic. There may be more mileage in working on standard-setting and tax arrangements in other forums. “The Biden view isn’t a million miles away from the French idea of ‘managed globalisation,’” says Tom Wright of the Brookings Institution in Washington. A joint trade and technology council, proposed by the EU, could help push for common standards in new technologies such as AI. Other democracies could be invited to join.

In the digital sphere, although old tensions on data privacy and competition may flare up, Tyson Barker at the German Council on Foreign Relations (DGAP) notes a convergence as American regulators grow alert to the challenges of Big Tech. One tripwire is a tax on digital giants approved in several European countries; retaliatory tariffs are threatened against France’s. A recent report by the DGAP and the Harvard Kennedy School urges a 12-month moratorium on such actions while the partners thrash out a common approach inside the OECD, a rich-country club.

And the third basket? The two sides must soften tensions. Old American concerns that some Europeans, notably Germany, are delinquent on military spending will not end with Mr Trump’s exit, but nor will they be used to bludgeon Europeans into compliance. European efforts to share the security burden, including military mobility, cyber-defence and even anti-corruption, should find a receptive ear in Washington, especially if they can reduce tensions in the EU’s neighbourhood. But French-inspired attempts to forge “strategic autonomy” in defence will meet resistance if seen as undermining NATO.

The threat of secondary sanctions by America on entities linked to projects disliked by Congress became a major transatlantic irritant in the later Trump years. Nord Stream 2, an undersea Russian gas pipeline, was often targeted: Congress recently handed Mr Trump the power to impose sanctions on firms linked to it. Should he exercise it before leaving office, Mr Biden will face an awkward early choice.

The burgeoning contest with China, increasingly threaded throughout American foreign policy, may prove the biggest trans-

atlantic test. The EU sees China in part as a “systemic rival”, language that should open space for common action. Mr Biden says a “united front” would give democracies “substantial leverage” over China. Yet on December 30th the EU agreed with Xi Jinping the outline of an investment deal that drew criticism at home and in America (see Chaguan). Some Europeans boasted that this was “strategic autonomy” in action.

For all the grumbles, Mr Biden’s team does not expect the deal to forestall deeper transatlantic co-operation on China, including at the WTO. But a more focused American approach could leave Europeans with hard choices. They will resist American entreaties to decouple fully from China—indeed, many firms are beefing up their Chinese investments (see Business section)—or to apply a geostrategic test to all economic relations. Europeans themselves are split on China, notes Peter Beyer,

the German government’s transatlantic co-ordinator. But they will be open to discussions on shock-proofing supply chains, building joint standards, and harmonising approaches to foreign investment and in some cases to export controls. The departure later this year of Angela Merkel, a champion of engagement with China, may shift the political balance in Europe.

Hanging over the relationship will be what Metin Hakverdi, a German Social Democrat MP, calls the “big question: was Donald Trump the exception, or will Joe Biden be the exception?” Fears that Mr Trump, or someone like him, may return in four years could inspire strategic hedging on Europe’s part, from boosting sovereign capabilities in defence and tech to seeking allies elsewhere. But it also implies doing everything to help Mr Biden fulfil his promise to his voters: that America is strongest when it works with its allies. ■

## Spain’s government

# Frenemies on the left

MADRID

## A government of unstable stability

A YEAR AGO Pedro Sánchez embarked on a political experiment. After two indecisive elections, he swallowed his previous qualms and formed Spain’s first coalition government since the 1930s, between his Socialists and Podemos, a hard-left party. Within weeks, this minority administration was faced with the pandemic, which has hit Spain especially hard. Yet it survived. Last month Mr Sánchez secured parliamentary approval for a budget, the first since he came to office in 2018. Spanish budgets can be rolled over, so the government now has a chance of serving out its

term, which lasts until 2023. But in a country where politics is deeply polarised, the coalition will not have an easy ride.

Mr Sánchez’s critics argue that he has survived only by lurching far from the mainstream. Take the manoeuvring over the budget. Pablo Iglesias, who is Podemos’s leader and a deputy prime minister, pushed the government to seek the votes of the five parliamentarians of Bildu, a political successor to ETA, the Basque terrorist group. To gain the 13 votes of Esquerra, a Catalan separatist party, the government also omitted from its new education law an ▶▶

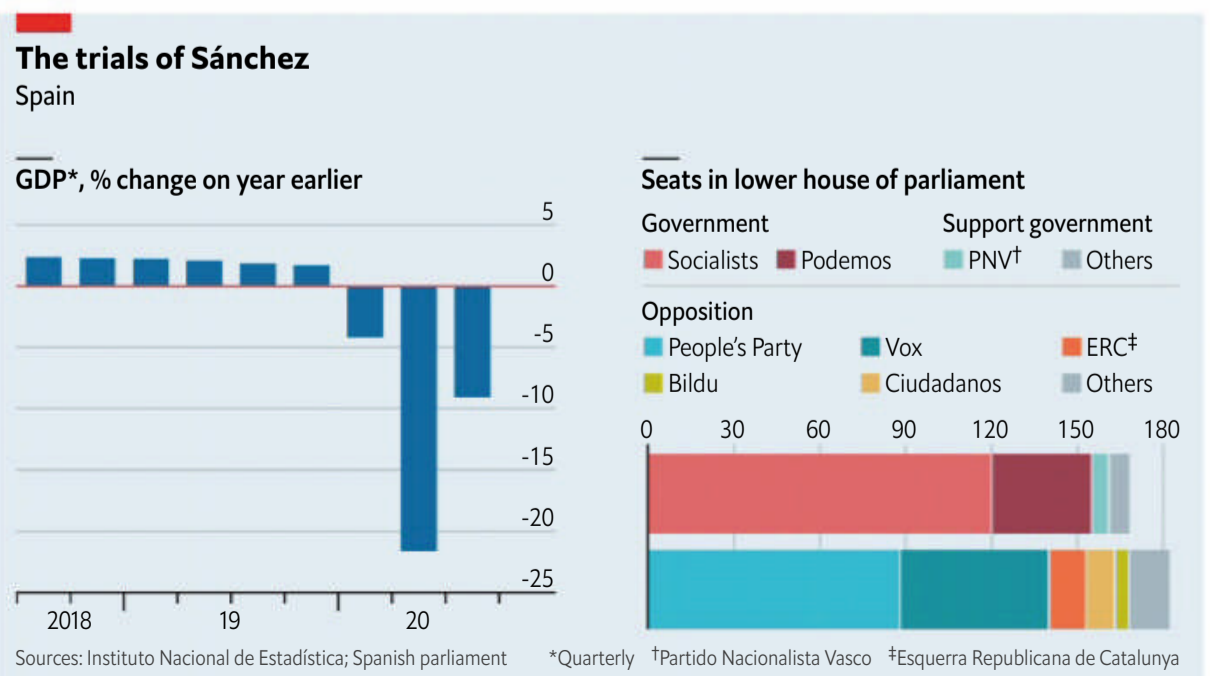



old stipulation that teaching should be at least partly in Castilian Spanish in regions with a second official language (though this has long been ignored in Catalonia). Mr Iglesias welcomed Bildu and Esquerra to “the leadership of the state”.

That is anathema to many Spaniards. In most European democracies Bildu would be shunned: its leaders have yet fully to condemn ETA’s long terrorist campaign for Basque independence, which ended only nine years ago. The government’s embrace of Bildu prompted criticism from even some Socialist regional leaders—a rare event in a party dominated by Mr Sánchez.

The prime minister argued that what mattered was the budget, which offers the country “a future of stability and progress”. In fact, its importance is political more than economic. Thanks partly to the weight of tourism and vulnerable small businesses, Spain’s GDP shrank by about 11% in 2020, the worst in the euro zone. Some 750,000 workers are still furloughed. With public debt heading for 120% of GDP, the government has been stingier with emergency aid than many of its neighbours. In these circumstances the budget’s increases in public-sector wages and in pensions, albeit small, look unwise.

The pandemic has sunk much of the coalition’s original programme, which featured big tax rises and spending increases and the repeal of a labour reform of 2012 that reduced union power and speeded job creation. The government’s hopes are now pinned on aid from the European recovery fund: it expects to get €27bn in 2021. The European Commission is likely to insist on structural reforms to make the labour market work better and to reduce pension spending—both of which offend Podemos.

The opposition sees the monarchy and the judiciary, as well as Europe, as bulwarks against a leftist surge, but it thinks both are now under assault. Podemos, which wants to get rid of the monarchy, has pounced on financial scandals surrounding Juan Carlos, who abdicated as king in 2014 in favour of his son, Felipe, and is being investigated over a payment in 2008 of \$100m from Saudi Arabia, most of which he turned over to a former lover.

Unusually in Europe, in Spain the judiciary’s governing council is chosen by parliament, by a supermajority that requires the two main parties to agree. The council’s term ended two years ago but the conservative opposition Peoples Party (PP) has blocked its renewal, saying that it does not want Podemos to have a say on the body. That prompted Mr Sánchez to propose a bill lowering the necessary majority, only to withdraw it after the European Commission objected: it smacked of the rigging of judiciaries, as in Poland and Hungary.

Mr Sánchez’s alliances have provoked the hard right. In November more than 100

## Gibraltar

## Between a rock and a softer place

MADRID

Spain and Britain do a deal

GIBRALTAR IS “a perfect synthesis of Britishness and the Mediterranean way of life”, boasts Fabian Picardo, its chief minister. It has red telephone boxes and a Marks & Spencer, but its 34,000 people often lapse into *Llanito*, a kind of Spanglish, and their daily lives are intertwined with Spain’s. No wonder that 96% of them voted in the referendum in 2016 for Britain to stay in the EU. On December 31st Gibraltar got some consolation for Brexit in the form of an agreement that softens what is now a hard border. It was a victory for common sense.

Gibraltar’s economy turns on services: finance, online gambling and tourism. It exports few goods. But it depends on some 10,000 workers who cross each day from Spain, and relies on its Spanish hinterland for space for homes and business expansion. The agreement aspires to freedom of travel between the Rock and Spain. A corollary is that Gibraltar’s airport and port will be the external border of the EU and will fall within the Schengen passport-free area. Arriving passengers, including Britons, will have their passports checked first by Gibraltar’s police and then by Frontex, the EU’s border agency, working in conjunction with Spanish police.

Many details are still to be hammered out before this outline agreement becomes—later this year, diplomats hope—a treaty between the EU and Britain. It involves delicate fudges. Spain has long claimed sovereignty over Gibraltar, though it yielded it in the Treaty of Utrecht of 1713. In a referendum in 2002 Gibraltarians voted overwhelmingly to

retired military officers signed open letters to the king complaining that the “social-communist government, supported by ETA-lovers and separatists” is threatening national unity. The defence ministry insists the malcontents are only a small minority. They have been encouraged by the rise of Vox, a hard-right party.

“We’re not seeing irreparable damage to the constitution,” says Pablo Simón, a political scientist at Carlos III University in Madrid. Much of the disquiet, rather, stems from the power dynamics within the coalition. Podemos “is eating the Socialist Party” which is more and more influenced by its junior partner, according to Pablo Casado, the PP’s leader. Socialist sources report that Mr Sánchez has tamed Podemos. His own people run economic and foreign



Fudging the frontier

remain British. Some Spanish right-wingers saw Brexit as a chance to push for sovereignty. But the biggest losers from confrontation would be the Spanish towns in the Rock’s hinterland, some of the poorest in Spain. In La Línea, for example, unemployment is already 27% and drug-traffickers are powerful.

Until the treaty is signed, the hard border will be lightly enforced. With Gibraltar and La Línea both locked down because of covid-19, there is little traffic at the moment. “This deal will have many enemies,” warns a diplomat. But if it sticks, both sides have much to gain. Mr Picardo talks of a “bay of prosperity” where investors see enough certainty to take advantage of the Gibraltar region’s strategic position close to north Africa.

policy, whereas Podemos’s portfolios, with the exception of the labour ministry, are decorative. But Mr Iglesias and his team, fearing irrelevance, make a lot of noise in the media. Mr Sánchez responds with tactical ambivalence. “One day he talks left, the next day he returns to an institutionalist discourse,” says José M. de Areilza, a law professor.

Opinion polls are starting to show a shift towards the right as well as disillusion with politics. With the budget approved, Mr Iglesias’s value to Mr Sánchez has diminished. But it has not disappeared. The prime minister is unlikely to want to face the voters again until they can feel economic recovery. If so, he may be condemned to his turbulent political marriage for at least another year. ■



## Greece

## Laptops at the ready

ATHENS

**The lockdown has helped Greece to digitise**

GREECE RANKS at or near the bottom of the EU class on digitisation, whether you measure it by high-speed internet connections, ownership of laptops and tablets, or online shopping. The government's digital-transformation "bible", a scheme to catch up with European peers by 2025, which includes 400 separate projects, is months behind schedule. Yet the country's second lockdown in November (now set to last until at least January 11th) has spurred an unexpected leap forward in one important area: distance learning.

Under a new law passed in the summer, schoolteachers can be required to hold all classes online, from pre-school nurseries to sixth forms preparing for university-entrance exams. When the spread of coronavirus shut down schools across the country in March, maths and science teachers had little difficulty moving lessons online. But some history and literature specialists without digital skills refused to co-operate.

"Now distance learning is mandatory and a new curriculum is being rolled out online," says Niki Kerameus, the no-nonsense education minister in the right-of-centre government of Kyriakos Mitsotakis, which took office in 2019 after four years of rule by the radical left-wing Syriza party. Teachers who fail to show up for an online class face disciplinary action.

Ms Kerameus, a high-flying New York lawyer before she entered politics, says that Greek schools had only 4,500 portable devices when the government came to power last year. Now more than 90,000

tablets and laptops have been handed out, paid for by EU funds, local government and private donations. Cisco, a telecoms-equipment company, set up a Webex platform which can provide simultaneous access for the country's 1.4m pupils and 180,000 teachers. Teachers have attended online training sessions; some began Facebook groups to provide continuous tech support. Even when normal life resumes in classrooms, digital learning will remain a big part of the syllabus, Ms Kerameus says.

Schools shut down again in November after a second coronavirus wave hit Greece. The new online teaching system went live two days later. When a chaotic first session triggered a social-media storm of protests from angry parents, glitches were quickly smoothed out. "We're feeling very encouraged," says Eleni Hatzi, deputy head of a secondary school that serves Greece's Muslim minority in Thrace, an impoverished region close to the border with Turkey. "We have a record number of students taking university entrance this year and they have many new resources because of the digital programme."

A pilot pre-school programme for four-to six-year-olds launched in 2019 in Larisa, in central Greece, can now continue digitally with the help of parents, despite the lockdown. Stella Boura, who runs it, says her pupils are enjoying distance learning. "They feel comfortable because they can interact with their teacher as usual. They're keeping up with early-learning English classes, shopping games and singing."

Ms Kerameus admits that her task of keeping education on track during the pandemic was made easier because of Greece's old-fashioned centralised school system. At present the education ministry keeps a tight grip on everything, from details of the curriculum to timetables and even school excursions. "Our aim is to decentralise the system," she says. "But right now [the old system] has actually been a help." ■

## The Dutch monarchy

## Bruised Oranges

AMSTERDAM

**A king botches covid-19 etiquette**

POLITICALLY, COVID-19 has been good for Mark Rutte, the Netherlands' prime minister. Polls show his party's support has risen from about 15% to 25% since March. Not so for his sovereign, King Willem-Alexander. In April 76% of Dutch said they trusted the king; in December that had dropped to 47%, according to Ipsos, a pollster. Support for the monarchy as a whole fell from 74% to 60%. The main cause seems to be two disastrous holidays. In August Willem-Alexander and Queen Maxima were photographed breaking social-distancing rules in Greece. In October the family returned there during the Dutch autumn break, even as the Netherlands headed towards a lockdown. The trip was cut short by public outrage.

The House of Orange has been one of Europe's most popular royal families. Its history is unusual. When the Netherlands won independence from Habsburg Spain in the late 1500s, it started out as a republic. The descendants of William of Orange, the nobleman who led the revolt, were given the odd title of "stadtholder". They tussled for power with the provincial delegates of the States-General. In 1795 Dutch progressives backed by revolutionary France drove out the Oranges, who took refuge in England. It was not until 1815, when they returned after Napoleon's defeat, that they became royalty, with the help of the anti-republican British and their allies.

By the 1900s they were typical constitutional monarchs. They won kudos in the second world war, since Queen Juliana fled to London rather than accept Nazi occupation. Though Willem-Alexander signs all laws, his main job is to meet business groups and charities and to give an annual speech (written by the government). Like other modern royals, they appeal to the people by mixing pomp and folksiness.

This year's shenanigans upset that balance. The royals disregarded covid-19 rules while flaunting their wealth: the king brought along his new yacht worth €2m (\$2.5m). "The Netherlands has a culture of 'Stick your head up and get mowed down', so the Oranges usually try to seem normal," says Kysia Hekster of NOS, the national news broadcaster. The royals cost the state €46m a year for salaries, events, palace upkeep and so on. But their private fortune is secret. The Oranges are still well liked, but many Dutch think they have a right to know what is beneath the peel. ■



The new panopticon



# Charlemagne | The clown ceiling

*Why the European Union is lucky in its enemies*



IMAGINE THE dinner party from hell and it would look a lot like the one politicians from Forum for Democracy (FVD), a Dutch far-right party, held in November. It began with a row over the backing music, with guests torn between classical music or Ava Max's "Kings & Queens", a trashy dance hit. Over lobster and wine, allegations of anti-Semitism among the party's youth ranks were dismissed by its leader, Thierry Baudet. Guests were asked how many people they would let die for the sake of freedom ("three million" was Mr Baudet's offer). Later, the FVD's leader suggested that covid-19 was the work of George Soros. In the days that followed, as accounts of the dinner surfaced, politicians from the party lined up to quit. It was a spectacular collapse after a remarkable rise. Founded only in 2016, FVD was feted as the future of the far right in the EU, briefly topping opinion polls in 2019. Its piano-playing, Hegel-quoting leader was breathlessly profiled in the press. Now it goes into a general election in March hoping for a few seats at best.

A clown ceiling exists in EU politics, which has kept Eurosceptic parties such as FVD from gaining too much power. Such parties tend to grow quickly before collapsing, often due to their own risible ineptitude. The pattern repeats itself across Europe: a rapid ascent, a noisy thud against the ceiling and a swift retreat. In Germany, Alternative for Germany (AfD) emerged in 2013. By the 2017 election, AfD was the biggest opposition party in parliament. Since then, it has been marred by far-right extremism and infighting, both metaphorical and physical. (During one row, a senior AfD politician gave a colleague a "friendly bop to the sides", which ruptured his spleen.) Once known as the "professor party" because of the boffins in its ranks, it is now associated with thugs. In Europe, those who are most willing to lead upstart movements are often the least suited for the long-term task.

Some parties have managed to punch a hole in the clown ceiling, but not one big enough to break through. Traits that lend themselves to insurgency do not translate well into governance. The Northern League, an Italian hard-right party, took power in 2018. A year later, while riding high in the polls, Matteo Salvini, its leader, brought down his own coalition to try to trigger an election. It backfired and Mr Salvini found himself back in opposition with his party's polling dented. Sometimes, the failings are ones of

character. In Austria, the far-right Freedom Party was in power before footage emerged of its leader lounging on a sofa offering state contracts to someone he thought was the niece of a Russian oligarch. A jester in government can swiftly look out of place.

Fortunately for the EU, hostile parties outside it often seem just as clownish. Britain mucked up leaving the EU so badly that no other country looks likely to copy it. In 2016 EU officials feared Britain's exit. They worried that Britain could be a nimble, efficient state on its borders. Instead it became a big flailing one. Britain needed four years, three prime ministers and two elections to fully leave the bloc. Rather than striding out as a proud independent state, it waddled out of the EU with its foot in a bucket. In the eyes of some of its European peers, Brexit has turned Britain into a clown state.

Britain is at least a friendly clown. The same cannot be said for Russia and Turkey, which actively try to undermine the EU. But they pose a problem because they are large and close to the EU, not because they are well led. Recep Tayyip Erdogan keeps on overplaying his hand. A failed plot to bus migrants to the EU's border demonstrated the limits of Mr Erdogan's powers, rather than their potency. Likewise, Vladimir Putin is often credited with blood-curdling geopolitical cunning. But the reality is not always so fearsome, if his government's latest attempt to kill its leading critic, Alexei Navalny, is anything to go by. A scheme to poison his underpants was unwittingly exposed by one of the would-be assassins in a jaw-dropping recorded phone call with Mr Navalny. Mr Putin and Mr Erdogan are sometimes more slapstick than sinister.

Even the more intellectual critics of the EU cannot escape the circus. Their points are often valid. Few argue today that building a monetary union without a proper lender of last resort was a bright idea, or that the EU's handling of the refugee crisis was a masterclass of policymaking. Where the critics erred was in assuming that such problems would inevitably lead to the EU's collapse. This takes the pressure off the EU. But avoiding destruction is a low bar to clear, if success is defined by mere survival.

## When the circus gets serious

Criticism by clowns can lead to complacency. Because so many of the EU's opponents implode or cock up, the dangerous assumption exists that they always will. When the EU does go wrong, the fact that its loudest critics are jokers means the often-valid messages are ignored. EU politicians recall David Cameron's attitude to the UK Independence Party, which he dismissed as a bunch of "fruitcakes, loonies and closet racists". Ten years later, Britain was leaving the EU and Mr Cameron was out of a job. Being run over by a clown car is no joke.

Relying on the ineptitude of opponents is not viable in the long term, as Britain's exit attests. Within the EU, Hungary provides an example of what happens when a clever politician takes the reins of an insurgent party. In the past decade Viktor Orbán has made himself almost impregnable, outwitting attempts by the EU to frustrate him. Even poorly led insurgent parties still gather up to a quarter of the vote. This may simply be a natural limit of support. Euroscepticism is a minority pursuit in most countries, and voters are in general becoming more tolerant of matters like immigration which once gave outlandish parties a solid base of support. Attracting loyal voters requires competent leadership, which has—mercifully, from the EU's perspective—been lacking in far-right outfits. The clown ceiling has held solid. But, as Mr Orbán shows, those who smash through it can be hard to stop. ■



Free Financial Tools  
Wealth Management

**personal**  
CAPITAL  
AN  EMPOWER COMPANY

**“This new year, keep  
abundance in your  
thoughts and focus on  
financial well-being.”**

–Deepak Chopra™, MD  
Founder, Chopra Global

Author Deepak Chopra has a mission to empower personal transformation. A healthy, abundance-filled life begins with healthy habits. That’s why he’s working with Personal Capital to help people reduce stress and find financial confidence.

Start today by using our powerful, free financial tools to see where you stand—now, and for your retirement.

This new year, find financial peace of mind.

Download free financial tools today at  
[personalcapital.com/econ](https://personalcapital.com/econ)

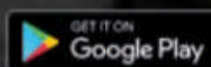
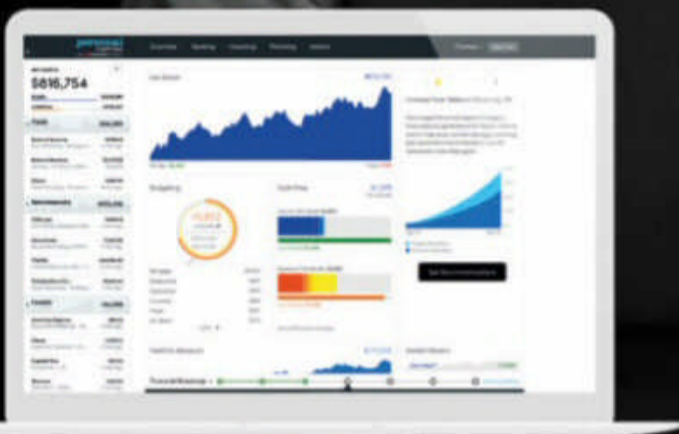

FREE FINANCIAL TOOLS AVAILABLE ON WEB & MOBILE

Featured individuals are paid spokespeople and not clients of PCAC and do not make any endorsements or recommendations about securities offerings or investment strategy. Advisory services are offered for a fee by PCAC, a wholly owned subsidiary of Personal Capital Corporation, an Empower company. Personal Capital Advisors Corporation (“PCAC”) is a registered investment adviser with the Securities and Exchange Commission (“SEC”). SEC registration does not imply a certain level of skill or training. Investing involves risk. Past performance is not a guarantee nor indicative of future returns. The value of your investment will fluctuate, and you may lose money. All charts, figures, and graphs are for illustrative purposes only and do not represent an actual client experience. Personal Capital Corporation is a wholly owned subsidiary of Empower Holdings, LLC. © 2020 Personal Capital Corporation, an Empower Company. All product names, logos and brands are property of their respective owners. All rights reserved.





## Covid-19

## Racing the virus

**A new, more transmissible variant leaves one Londoner in 30 with covid-19, placing perilously high stakes on the delivery of the vaccine**

SCIENTISTS BELIEVE a new variant of covid-19 first passed from one person to another in Kent, in the south-east of England. When it happened, in late September, there were just 79 patients in hospital with the virus in the nine counties that make up the region. Three months later admissions are running higher than during the spring peak. “We haven’t run out of oxygen or dexamethasone or ventilators,” says a local doctor. But medical staff are dangerously thin on the ground: “We are very close to running out of humans.”

Britain is now in a race against the virus. The new variant, which is 50-70% more transmissible, is spreading fast. Having been concentrated in the south-east in the autumn, it has now taken root across the country (as well as beyond Britain’s borders, turning up everywhere from New York to Sydney). Much as Lombardy alerted the world to the pressures covid-19 would place on hospitals, south-east England provides a warning about the impact of the new variant.

The lack of testing during the first wave makes comparisons difficult, but calculations by *The Economist* suggest the number of cases in England and Wales is now at around 80% of last year’s peak, and is rising fast (see chart overleaf). According to estimates by the Office for National Statistics, one in 30 Londoners had covid-19 in the week ending January 2nd, as did one in 50 Britons overall.

The government is trying to contain the spread. On January 4th Boris Johnson announced another national lockdown. Yet

---

→ **Also in this section**

---

**48 Losing digital privacy rights**

---

**49 EU citizens**

---

**50 Bagehot: Patience wins**

---

Read more from this week’s Britain section:  
[Economist.com/Britain](https://www.economist.com/Britain)

the prime minister was once again slow to react, doing so a fortnight after the Scientific Advisory Group for Emergencies, an official body, advised that stronger measures would be necessary, and the day many pupils returned to school. Schools and universities have now closed to most students. Outdoor socialising with another person is permitted only if it involves exercise. Scotland, Wales and Northern Ireland have introduced similar measures.

The National Health Service is under strain. Unlike in the first wave, supply chains are holding up and treatment protocols are in place. Patients admitted to intensive-care units are now a bit more likely to survive. But death numbers are rising fast, breaching the 600-a-day mark on December 28th, the current peak (it takes time for deaths to be recorded).

The jump in cases is wreaking havoc. Ambulances are queuing up outside hospitals. In a letter seen by ITV News, one institution in London warned staff: “We are now in disaster medicine mode. We are no longer providing high standard critical care, because we cannot.” A doctor in Kent says that patients have been transferred to intensive-care units in Southampton and Plymouth, which is 250 miles away, because of bed shortages. One concern is that opportunities for this sort of mutual aid will become limited as hospitals fill up across the country.

New restrictions should ease the pres- ▶▶



sure. Yet not all scientists advising the government are confident they will be sufficient to halt the growth in the number of cases, given the increased transmissibility of the new variant. Case counts in the south-east have levelled off, even if they have not begun to decline. But during the Christmas break, London's restrictions were equivalent to the national lockdown, with schools closed for the holidays and most offices shut—and still cases grew.

The optimistic interpretation is that this was because people broke the rules over Christmas; the hope is that behaviour will change now Britain has entered, in the words of one scientist, a “real lockdown”. According to data from Google, mobility in London was around 60% lower than normal at the end of the year. Even with the reduction in movement that would be expected over Christmas, as people watch rubbish television rather than head into the office, that was not as low as the 70% reduction during the spring lockdown. As ever, the introduction of new restrictions received widespread support. A poll by YouGov found that 85% back the lockdown.

There is not much more behaviour that the government can restrict should cases continue to rise. Nurseries remain open and single households can still form “support bubbles”. People are allowed into workplaces if it is “essential” (which they can define). Once in, they do not have to wear a mask, unless they serve customers. Changing these rules is either unpalatable or unlikely to make a big difference.

Rapid delivery of vaccines is thus an overwhelming priority. In the face of the new variant, the Joint Committee on Vaccination and Immunisation, an expert group which advises the government, recommended prioritising first doses, with second ones held back for as long as three months (see Briefing). While announcing the new lockdown, Mr Johnson set a target of offering residents and staff in care homes, front-line health- and social-care workers, the clinically vulnerable and everyone over the age of 70 (who together

account for 13.6m people) a dose by mid-February. That would greatly reduce deaths and trips to hospital: those over 70 account for more than eight in ten fatalities.

So far 1.3m have received jabs, with Britain delivering more than any other European country, but at too slow a rate to meet Mr Johnson's target. If he is to succeed, roughly that many vaccines will have to be delivered every four days. The process should accelerate once the MHRA, a regulator, approves more batches of the Oxford-AstraZeneca vaccine, and the Pfizer-Biontech doses freed up by the dosing strategy are dished out. Next week nearly 1,000 vac-

cination sites, operated by general practitioners (family doctors) and hospitals, will be joined by seven mass-vaccination centres in exhibition centres and stadiums.

It should not take long for this to lighten the health service's workload, and for the vaccination of medics to reduce staff absences. Yet with hospitals already overloaded, the next few weeks will be bleak. “The thought of [case counts] going up any more is pretty awful,” says the doctor in the south-east. The case for getting vaccines out quickly, always strong, has only strengthened. Any slip-ups in the roll-out will come with a heavy toll. ■

Losing digital privacy rights

## Chlorinated Facebook

Why tech giants are transferring legal responsibility for British data to America

GOOGLE AND Facebook collect more data about what people are doing on the internet—the web pages they read, the services they use, the links they click—than any other companies. Those data are used to construct profiles of internet users, against which personalised advertisements may be sold. This year, as a consequence of Brexit, the firms are moving legal responsibility for that data from Dublin, where it has sat for the past few years under European law, to California, where both technology firms have their headquarters.

Bits of data themselves will not physically move—datasets are already copied onto servers around the planet in order to ensure reliable service independent from geography. It is legal responsibility for those bits that is moving, some time in 2021. Google and Facebook users in Britain will be informed of the move through one of the regular, tedious sets of terms and conditions which they are asked to accept.

Google's and Facebook's move means that British residents will no longer have recourse to European data-protection law. Rather as American food standards are easier on farmers than European ones, which leads to chicken meat being washed in chlorine, so the absence of national privacy or data-protection law in America means that its digital giants can, for instance, deploy face-recognition technology with relative ease. As long as legal authority for a profile remained in Europe, that person, regardless of location, could bring a complaint under European law. Upon acceptance of the new terms, Britons will lose the protections of European law.

In principle that should not matter. British data-protection law is a close

copy of Europe's GDPR, and Britons will still be protected by that regardless of the jurisdiction that administers their data. But practical concerns mean the transfer will make a difference. First, Britain's Information Commissioner's Office will face the task of regulating giant companies some 5,000 miles away, which may be a struggle for a body that has not excelled at regulating activity even on British soil. Trying to project British law, should Facebook or Google ever break it, into California will be messy, even for post-Brexit Britain at its most global. Dublin was more convenient.

Second, America's large tech companies are now free to lobby Westminster for favourable changes to Britain's data-protection law, something which would have been pointless while their legal responsibilities lay in Dublin under European law. It is plausible, says Michael Veale, a lecturer in digital rights at University College London, that tech giants may seek to make Britain a regulatory beacon to Europe through this lobbying, working with the newly flexible, newly sovereign British government to demonstrate the benefits of a new deal on data protection.

It is also plausible that Britons' standards of data protection will be downgraded over time through this lobbying, although that would risk triggering a fight with the EU over adequacy, and threaten the flow of data between Britain and the EU. It is more likely that, when it comes to their relationship with American tech giants, Britons will be stuck in a post-Brexit quagmire, with an under-resourced regulator trying to control powerful companies thousands of miles away. The EU, for all its faults, kept the locus of control closer to home.

### The spike spike

England and Wales, reported v estimated\* new covid-19 infections, weekly totals, m

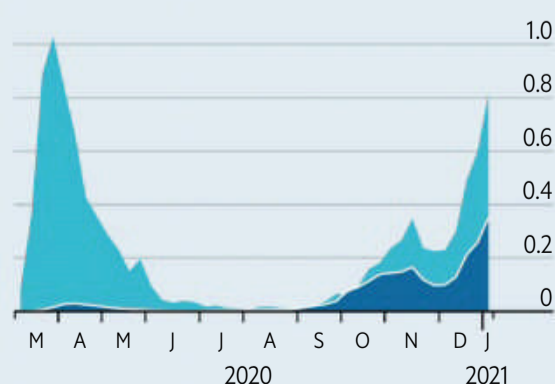

Sources: ONS; government statistics; The Economist

\*By The Economist's seropositivity model



## EU citizens

## Remainers

CORBY AND KENSINGTON

**Brexit is over. But many corners of Britain will be forever European**

TALK TO ONE of the 4m or so Europeans in Britain, and they will probably tell you the same story. They intended to stay for a year or so—long enough to study, polish their English or save up for a better life back home. And then, somehow, one year became two, which became 20. Maria Torrent-March came from Spain on the Erasmus programme, as part of her five-year degree. In the kitchen of her student lodgings, she met an English fellow student; soon they were dating. “Do I go back to Spain, or do I give the boy a chance?” She chose the boy.

After Britain voted to leave the European Union, many commentators predicted a “Brexodus”. Since Brexit would end free movement, dampen the economic rationale for staying in Britain and had in part been driven by anti-immigration sentiment, might not many Europeans up sticks just as easily as they had come?

For the most part, that has not happened. Although the pace of outflows has quickened a lot since the referendum (see chart), at least until the end of 2019—after which covid-19 makes migration data messy—more people were arriving in Britain than were leaving. The number of European nationals living in Britain rose from 3.2m in 2015 to 3.6m in 2019.

The government’s EU settlement scheme has received 4.4m applications, including one from Ms Torrent-March, who married “the boy”; they now have two daughters. Though some applications will have been filed by migrants who have since left or as an insurance policy by Europeans with no current plan to live in Britain, the numbers hardly point to a Brexodus.

Nor are most poised to leave at any moment, should Brexit bear out the direst predictions. The longer a migrant stays in a country, the less likely they are to leave, points out Madeleine Sumption of Oxford University’s Migration Observatory. By 2019, a little more than half of EU nationals had lived in Britain for a decade or more. They may have arrived footloose, but young migrants have a habit of growing older. In those ten years, some will have found good jobs, others will have earned British qualifications, got married or had children—all of which strengthened their ties to Britain. “I think most of these people will stay here for ever,” Ms Sumption says.

This suggests that, long after the last stars have worn off plaques on EU-funded

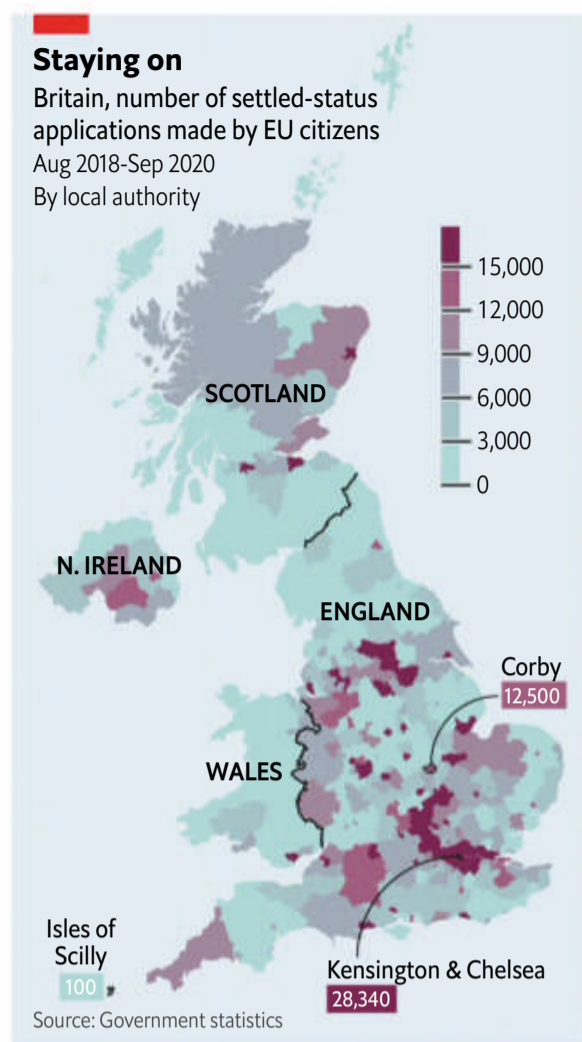

projects, Europeans themselves will remain one of the most tangible legacies of Britain’s 47 years in the European club, just as several generations of Britons with Caribbean or Asian ancestry are reminders of a long-dead empire and the brief period of unrestricted immigration that flourished at its end. In time, a comfortable European-British identity may emerge, says Sunder Katwala of British Future, a think-tank. Schools are already accustomed to enrolling children with at least one European parent; some 730,000 were born to European mothers in England and Wales in 2008-19. Births have slowed since the referendum, but Polish women still head the league table of foreign-born mothers. In another generation, children with two British-born parents may talk of having a Polish grandfather in the same way many are

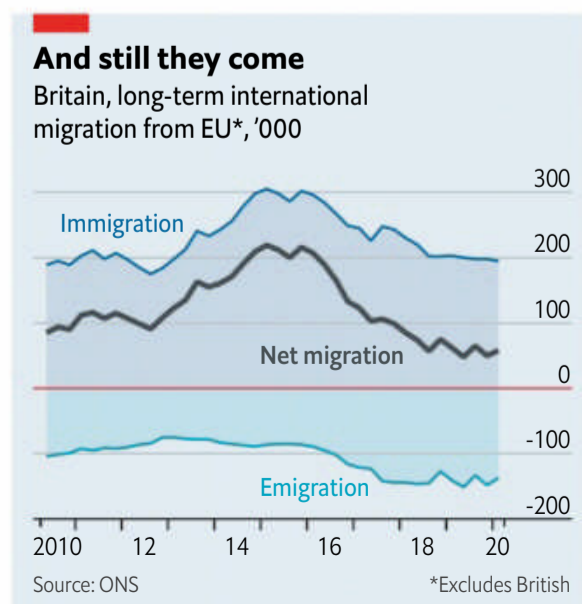

proud of their Irish heritage.

This will not only be true of big cities, but also, albeit to a lesser extent, of towns and rural areas (see map). Every local authority in Britain has been listed as a residence in at least several dozen settled-status applications. Even the Isles of Scilly have a band of Poles and Hungarians. Poles are particularly dispersed: they filed more than 500 applications in 298 of the 379 local authorities, compared with the 58 which saw 500 or more French applications.

Consider Corby, a town in Northamptonshire once synonymous with unemployment after the closure of its steelworks. More than 3,000 Poles have registered to stay put, out of the town’s total population of 72,000. Corby is now a popular home for logistics firms, which favour it for its central location and ready supply of labour. Ms Torrent-March runs operations at Europa, one of the firms with a big warehouse in the town. Of her 199 employees, 113 are European, a share that has not dwindled since the referendum. EU migrants make up 24% of the town’s population—the largest share in Britain.

On the second floor of a grey shopping parade in the town, there is now a Polish private medical practice managed by Maciej Kuzma and his partner, Anna. They both worked in a warehouse when they moved to Britain, seven years ago. But they soon found more lucrative jobs and saved enough to buy the surgery in 2017, undeterred by the referendum result. “The information about Brexit was surprising, but it wasn’t something that would stop us realising our plans, our dreams,” says Mr Kuzma. “Polish history is very rich. We’ve had an extremely hard past. Maybe we’ve just got used to being forced to adapt.” They now have 13,000 patients on their books and opened their second practice last year.

But London is always likely to have the greatest number of Europeans. The posh borough of Kensington and Chelsea alone was listed in more than 5,000 applications each by French and Italian nationals. The borough’s Lycée Français Charles de Gaulle remains popular with French parents. One of them, Caroline le Luel, moved from Paris in 2005 with her four-year-old daughter and two-year-old son; in time, she enrolled both of them at the Lycée. Her son is now in his final year and her daughter is at university. Even though they were educated at a French school, “they feel outsiders a bit when they are in France. I don’t think they will settle down there at some point.”

That helps explain why the family applied for citizenship after Brexit, despite finding the vote “very emotional”. “We are out of Europe, but people have settled their lives here,” she says. “We don’t see the United Kingdom as as much of a cool place as it used to be, but we still want to stay here. This is our home.” ■



## Bagehot | Patience wins

*The Scots have learned that the biggest prizes go to those who wait*



**P**ATIENCE IS A virtue underrated in politics. The business has always been full of young men and women in a hurry, who run even faster these days thanks to the 24-hour news cycle. Yet many of its giants played a long game. Disraeli did not lead the Conservative Party to victory until he was 69. Big political ideas often take time to mature. Clement Attlee and Margaret Thatcher both rode to greatness on the back of theories which, a generation before, had been regarded as bonkers.

The best example of the politics of patience is also the issue that has done most to shape modern British politics. The architects of the European Union paid little attention to the ebb and flow of day-to-day politics. They thought in terms of centuries rather than the daily news cycle—hence all those references to Charlemagne and Erasmus—and refused to take “no” for an answer if voters disagreed. The British Eurosceptics, ridiculed for decades by the country’s ruling class, had a similar long-term vision, seeing everything refracted through the European lens. That allowed them to ignore Brexit’s economic consequences. On a five-year time-scale, disrupting firms’ supply-chains matters. On a 500-year scale, it will fade into the mists of history.

The issue that more than any other will define British politics for the rest of Boris Johnson’s premiership, Scottish independence, is similarly dominated by long-termists. The nationalists’ commanding position—they have twice as many seats as the next party in the Scottish Parliament, and are likely to win even more in the next election in May—is the result of decades of unglamorous spade work, and they have displayed the same willingness to endure opprobrium as the Brexiteers. Their founding founders included a fair number of cantankerous cranks. Douglas Young, the leader of the Scottish National Party (SNP) in 1942-44, campaigned for the Scots to refuse conscription and was imprisoned for his troubles. The next generation featured ornery types unwilling to bow the knee to the Scottish Labour Party. When Alex Salmond joined the SNP as a student at St Andrews in 1973, he was one of only two local members. (Niche politics has its advantages: he instantly became president and his fellow-nationalist treasurer.)

The past is always present for Scottish nationalists, as it is for Europhiles and Europhobes. At SNP conferences, delegates talk of

the Battle of Bannockburn (1314) and the Declaration of Arbroath (1320) as if they were yesterday. Defeat is a temporary setback: a few months after Mr Salmond lost the 2014 independence referendum and resigned as SNP leader, he was back running for a seat in Westminster and flogging a new book, “The Dream Shall Never Die”. The party’s policy on university fees is a fine illustration of its strategic vision: abolishing them was expensive, but has helped preserve a sense of nationhood among the young by encouraging students to go to Scottish rather than English universities. According to a recent poll 67% of the young support independence, compared with 52% of the population as a whole.

The unionists have not, so far, shown a similar tenacity. After focusing on Scotland during the independence referendum and winning, they promptly lost interest. There are signs that this is changing. Policy Exchange, the Conservative Party’s favourite think-tank, is establishing a unit to look at the future of the union. Mr Johnson has appointed himself minister for the union.

On paper the prime minister holds all the cards, for he has the power to deny the nationalists a referendum. But in the game of patience, obduracy is not enough. He cannot secure the long-term future of the union without examining the reasons for the rise of nationalism and the widespread discontent with the over-centralised state. Doing so will require him to give his new portfolio sustained attention.

That may seem like asking too much of a man with a famously short attention-span, but Mr Johnson has more strategic patience than it appears—indeed, he may be a tortoise disguised as a hare. He recognised the European project’s vulnerability as long ago as 1989, as a journalist in Brussels, and exploited his insight all the way to the premiership. He needs to apply the same patience to the Scottish question as he has done to the European one, combining the art of delay with other skills: puncturing nationalist illusions, offering alternatives to the status quo and, given his unpopularity north of the border, working through surrogates.

Brexit demonstrated that the heart trumps the head when it comes to nationalism. Unionists need not just to explain how hard leaving would be, but also to challenge the nationalist account of the union at an emotional and cultural level. The nationalists present it as a takeover which involved the suppression of the Scottish people. The unionists need to persuade the Scots that it was a union of independent countries that benefited both parties, which is closer to the truth. The Scottish did well out of the British empire. Everybody did well out of the intellectual exchange that produced the likes of the Anglo-Scottish John Stuart Mill.

Unionists also need to counter the nationalists’ revolutionary constitutional proposal with innovations of their own. The Scots are not the only Britons who feel marginalised by Westminster: so do many English, Welsh and Northern Irish. Mr Johnson could propose to deal with their many discontents by establishing regional assemblies across England to go along with the Scottish and Welsh parliaments, and devolving more power all round. This would open many cans of worms, concerning the relationship of devolved authorities to each other and to Westminster. But the alternative is a disunited kingdom.

When Joseph Chamberlain called for Home Rule All Round in 1886 to tackle the Irish problem, Lord Birkenhead slapped him down by proclaiming that “We have muddled along tolerably well for ten centuries.” The muddle is no longer tolerable. Mr Johnson needs a long-term vision for a new, improved United Kingdom—and the patience to make it a reality. ■





Wikipedia at 20

## The other tech giant

On its 20th anniversary, Wikipedia's reputation has never been higher

LYING DRUNK in a field outside the Austrian city of Innsbruck in 1971, inspiration struck Douglas Adams, a science-fiction writer. He looked at his copy of “The Hitchhiker’s Guide to Europe”, and then up at the stars, and came up with the idea for a “Hitchhiker’s Guide to the Galaxy”. It would be a (fictional) mixture of travel book and encyclopedia, but with an absurd-seeming twist: instead of being written by experts, anyone could contribute.

Adams played his idea for laughs. But today it looks as prescient as it was funny. On January 15th Wikipedia—“the free encyclopedia that anyone can edit”—will celebrate its 20th anniversary. It will do so as the biggest and most-read reference work ever. Wikipedia hosts more than 55m articles in hundreds of languages, each written by volunteers. Its 6.2m English-language articles alone would fill some 2,800 volumes in print. Alexa Internet, a web-analysis firm, ranks Wikipedia as the 13th-most-popular site on the internet, ahead of Red-

dit, Netflix and Instagram.

Yet Wikipedia is an oddity. It defies the Silicon Valley recipe for success. The site has no shareholders, has generated no billionaires and sells no advertising. Today’s aspiring tech giants burn vast quantities of investors’ money subsidising taxi rides (Uber) or millennial messaging (Snap) in pursuit of “scale”. Wikipedia grew organically, as more and more ordinary people decided to contribute. The site has its roots in the techno-optimism that characterised the internet at the end of the 20th century. It held that ordinary people could use their computers as tools for liberation, education and enlightenment.

Like most Utopian thinking, the idea of an amateur encyclopedia was, for many years, treated as a bit of a joke. “A few endorse Wikipedia heartily. This mystifies me,” wrote a former president of the American Library Association in 2007. “A professor who encourages the use of Wikipedia is the intellectual equivalent of a dietician

who recommends a steady diet of Big Macs with everything,” he sneered. Even now, after numerous academic studies highlighting its reliability, Wikipedia still lacks the gravitas and authority of older encyclopedias like “Britannica”, which are written by paid academic experts rather than amateurs. Schools, universities and *The Economist’s* fact-checkers frown on relying on it.

Wikipedia may not have vanquished its doubters in theory. But it has triumphed in practice. With over 20bn page views a month, it has become the standard reference work for anyone with an internet connection. As social-media sites are lambasted for censorship, “fake news”, disinformation and conspiracy theories, its reputation is higher than ever. Toby Negrin, who sits on the board of the Wikimedia Foundation, the San Francisco-based charity that provides the site’s infrastructure, describes the online encyclopedia as a “guardian of truth”.

That sounds grandiose. But other tech behemoths now use it as a neutral arbiter. Conspiracy-theory videos on YouTube often come tagged with warning information from Wikipedia. Since 2018 Facebook has used Wikipedia to provide information buttons with the sources of news articles.

Others are also enthusiastic. In October the World Health Organisation (WHO) started working with Wikipedia to make information on covid-19 available via the site. It ►►



► considered the collaboration vital to its efforts to prevent an “infodemic” of misinformation about the virus. Brewster Kahle, the founder of the Internet Archive, which preserves websites for posterity, describes Wikipedia as “a treasure of the internet”.

Wikipedia’s value and influence are hard to compute. Its revenues come from charitable grants and donations from its users. “Wikipedia is an example of what I like to call ‘digital dark matter,’” says Shane Greenstein, an economist at Harvard who has studied the site closely. Like parenting and housework, contributing to it is a valuable service that, because it is unpaid, remains mostly invisible to standard economic tools.

A few researchers have tried to guess. One study in 2018 estimated that American consumers put a value of about \$150 a year on Wikipedia. If true, the site would be worth around \$42bn a year in America alone. Then add indirect benefits. Many firms use Wikipedia in profitable ways. Amazon and Apple rely on it to allow Alexa and Siri, their voice assistants, to answer factual questions. Google uses it to populate the “fact boxes” that often accompany searches based on factual questions. Facebook has started to do something similar. This drives traffic to Wikipedia from those keen to learn more. AI language models of the sort employed by Google or Facebook need huge collections of text on which to train. Wikipedia fits the bill nicely.

### The cult of the amateur

Its biggest power is its subtlest. Since it is the first resort of students, professors, journalists and any number of curious people, its contributors do much to make the intellectual weather. The WHO’s decision to work with Wikipedia reflects research suggesting that the site is the most-read source of medical information in the world—for doctors as well as patients.

Its reach is clearest when things go wrong. In 2008 one user inserted a joke claiming that the South American coati, a small mammal, is sometimes known as the “Brazilian aardvark”. By the time the jape was revealed, in 2014, it had found its way on to various websites and into news articles and a book published by a university press. In 2012 a senior British judge was caught out when, in a report on the shortcomings and criminality of parts of the British press, he named Brett Straub as one of the founders of the *Independent*, a newspaper. Mr Straub has nothing to do with the *Independent*. His friends had been adding his name to Wikipedia’s pages as a joke.

Yet despite a string of notable embarrassments—and its own disclaimer that “Wikipedia is not a reliable source”—it is, on the whole, fairly accurate. An investigation by *Nature* in 2005 compared the site with “Britannica”, and found little differ-

ence in the number of errors that experts could find in a typical article. Other studies, conducted since, have mostly endorsed that conclusion. Explaining exactly why Wikipedia’s articles are so good is trickier. A common joke holds that it is just as well that Wikipedia works in practice, because it does not work in theory.

Deliberate decisions are one explanation. Wikipedia compares well with other reference works when it comes to honest mistakes, but it is uniquely vulnerable to vandalism and pranks. In an effort to combat them, says Mr Negrin, the site has developed algorithms that monitor articles for mischief. For America’s recent presidential election, editing articles was restricted to accounts more than 30 days old, and with at least 500 edits to their name.

Other reasons are structural. The site’s open nature and its popularity help ensure that errors in well-read articles are usually spotted and fixed quickly. (By the same token, mistakes in more obscure entries may languish for years.) Mr Greenstein notes that, unlike with a printed encyclopedia, “another paragraph doesn’t cost anything”. That means that ideological rows can often be defused simply by adding paragraphs outlining different views. The site’s intimidating list of rules means that new editors face a steep learning curve. But it also helps to filter out dilettantes, ideologues and bores with an axe to grind.

Wikipedia’s not-for-profit structure, points out Mr Kahle, means it can focus on the interests of readers and editors without having to consider the (possibly conflicting) demands of advertisers. The site is unusual since it is run by humans, not algorithms. Though social-media sites rely on idiot-savant computer programs to maximise “engagement” (ie, to sell more advertising), Wikipedia’s humans try to uphold woolly ideals such as accuracy, impartiality and arguing in good faith.

Much of its success, in other words, is because of the culture its users have created. It is evident in the discussion pages that accompany every article, as the

site’s contributors debate with each other the noteworthiness of a topic, the quality of its primary sources, what information to include and to leave out, and more. Rules of thumb gradually become more solid guidelines. The Wikipedia page outlining the “Neutral Point of View”—one of the most widely discussed and referred to—runs to 4,500 words. It includes recommendations on how best to describe aesthetic opinions, which assumptions count as necessary, and which must be justified. It also points out the risks of providing “false balance” about controversial subjects.

Cultures constantly change. Relying on Wikipedia’s current one may, therefore, seem a risky strategy. Katherine Maher, the Wikimedia Foundation’s executive director, says that if Wikipedia did not already exist it might not be possible to create it on today’s fragmented, commercially minded internet. But given that it does, she is bullish about its prospects for survival. Much of the site’s work appeals to human nature, she says: “People love to be right, to demonstrate their competence.”

Even errors can be helpful. Ms Maher cites Cunningham’s Law, which holds that “the best way to get the right answer to a question on the internet...is to post the wrong answer.” She recalls meeting a committed Chinese editor who began contributing to the Chinese-language project because “a lot of what he saw was just wrong, and he felt he had to fix it!”

Keeping Wikipedia’s culture healthy means moving with the times. “Wikipedia is a child of the desktop internet,” says Mr Negrin. But “increasingly, when people talk about internet users, they’re talking about smartphones.” So the foundation is improving the site’s mobile-editing tools. Typing long articles on a smartphone is inescapably awkward, so attention has focused on helping users to make “micro-edits”, such as fixing spelling mistakes or correcting dates. The hope is that this will also act as a gateway drug for young editors and for those in poorer countries for whom smartphones are the standard or only way of getting online.

Attracting a steady supply of new editors is vital for Wikipedia’s long-term survival. So is attracting new kinds of contributors. Ms Maher estimates around 80% of Wikipedia’s editors are male, and skewed towards North America and Europe (see Graphic Detail). The encyclopedia itself is popular in America, Europe, Russia and Japan, but not much read in India and sub-Saharan Africa (see chart). Changing that, she says, is vital to the health of a project whose idealism remains undimmed. “Our vision is a world where every single human being can share in all knowledge,” she says. This time, such Utopianism is harder to dismiss. After all, it is backed up by 20 years of success. ■

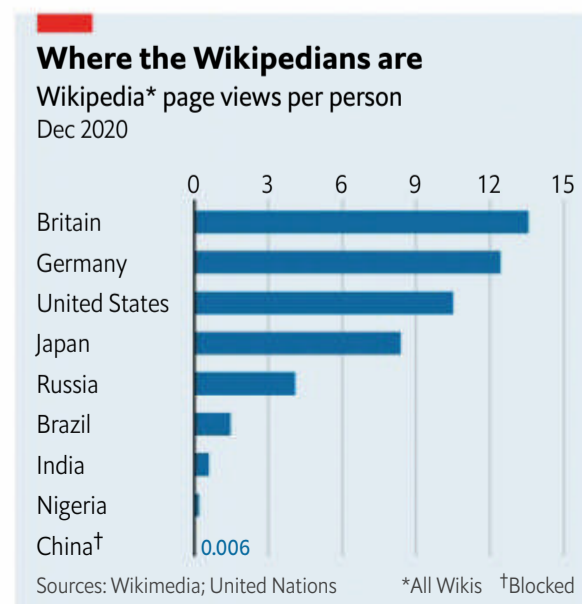



→ Also in this section

- 54 NYSE dithers on China Inc
- 55 A Stellantis is born
- 55 Rekindling corporate nuptials
- 56 Big oil and the Arctic
- 56 A corporate-charity experiment
- 57 Bartleby: Network effects
- 58 Schumpeter: A tech CEO's guide to dodging taxes

Deutschland AG in China  
**Riding high**

BERLIN

**German companies will keep pouring billions into China, never mind geopolitics**

THE IDEA of “political change through trade” has lost its appeal across much of the West as China has grown more, not less, authoritarian under President Xi Jinping. That has not stopped Karl Haeusgen, chairman of Hawe, a maker of hydraulic pumps, from believing in the long-term success of its German version, *Wandel durch Handel*.

Mr Haeusgen has a self-interested reason for optimism. China accounts for about one-quarter of Hawe’s sales. This will grow substantially once a 25,000-square-metre factory in Wuxi near Shanghai is finished. On January 1st Ye Jiang, an engineer who has worked for the family firm since 1999, joined its management board as its first Chinese member.

Many German bosses are in a similar situation. Goods trade between the EU and China grew eight-fold between 2000 and 2019, to €560bn (\$626bn). In 2019 Germany accounted for 37% of that, or €206bn. In the first seven months of 2020 German business helped China edge out America as the EU’s largest trading partner. Between January and September China’s share of German exports rose by one-eighth, year on

year, to nearly 8%. China is also Germany’s top supplier; its share of German imports rose to more than 11% in the same period, from less than 10% in 2019.

Although the most China-dependent American companies, like its casino operators and chipmakers, get more of their revenues from the Asian giant than the most exposed German firms, German Sino-de-

pendency is concentrated in its biggest and most powerful industries (see chart). Of Germany’s 15 most valuable listed firms, ten derive at least a tenth of revenues from China, according to *The Economist’s* rough estimates; in America, less than half do.

That is why German business applauded the hasty conclusion last month, in the last days of Germany’s rotating presidency of the EU Council, of an investment treaty between the bloc and China. The deal is meant to grant European firms better access to the Chinese market by, for instance, removing the requirement that they form a joint venture with a local firm and creating a more level playing field for investors.

Deutschland AG’s peculiar reliance on China also helps explain its reluctance to heed the German government’s pleas to diversify markets and supply chains away from the Asian giant. Indeed, many German firms, from medium-sized *Mittelstand* stalwarts like Hawe to its bluest chips, are doubling down on the Middle Kingdom. Hahn Automation, which makes industrial robots, plans to invest millions of euros in new Chinese factories and boost its revenues in China from 10% of the total to 25% in the next five years. BASF is building a gargantuan \$10bn plastics factory in the southern province of Guangdong, the biggest investment in the chemicals giant’s 155-year history. “We have to play ball with the Chinese,” says Joerg Wuttke, the German head of the EU chamber of commerce in China. “If you are not at the table, you are on the menu,” he warns.





▶ The loudest cheerleaders are in Germany's car industry. "China is the present and the future of German carmakers," says Noah Barkin of Rhodium Group, a research firm. As the world's biggest market, China accounts for two in five cars the Volkswagen Group sells globally. Without China it would have been hit harder both by the "Dieselgate" emissions scandal and by the pandemic. China is the biggest foreign market for BMW, a Bavarian rival, whose sales there rose by 31% in the third quarter, year on year. In December Ola Källenius, boss of Daimler (in which two Chinese carmakers hold a combined 15% stake) hailed a "remarkable" recovery in China, the largest and most lucrative market for its Mercedes-Benz brand, whose sales grew by double digits for six straight months.

German carmakers are also becoming more reliant on China for their capacity to innovate, notes the Mercator Institute for China Studies, a think-tank. In September the new ix3 electric car rolled off the production line in Shenyang, where it was also wholly developed by BMW and its Chinese state-run partner, Brilliance Auto. The joint venture also opened a new battery factory in the northeastern city. Volkswagen and its Chinese partners pledged to invest €15bn into e-mobility in China by 2024. VW recently bought a stake in Gotion High-Tech, a maker of batteries, to bolster its "electrification strategy in China". Daimler's latest annual report calls China "a significant market for new technologies".

No wonder carmakers are genuflecting before China's Communist Party. According to the *Süddeutsche Zeitung*, a newspaper, in 2012 Volkswagen opened a loss-making plant in the western city of Urumqi, in exchange for permits for new, lucrative factories on the eastern coast. VW denies the accusation. It has kept its Urumqi plant running, despite pressure from activists and politicians in America and Europe to stop doing business in Xinjiang province, where the authorities have been persecuting the Uyghur Muslim minority (see United States section).

Some voices in corporate Germany are worried that this is short-sighted. Two years ago the BDI, one of the two main German industry associations, published a paper outlining its concerns about high barriers to entry, state subsidies to local firms and other distortions in the Chinese market. Although it now praises the new investment treaty, the BDI warned that its members should be under no illusion: even once the pact is ratified by the European Parliament and implemented, German firms will not have truly free access to the Chinese market.

Chinese firms are also increasingly competing with German ones, particularly in the sort of specialist machinery manufactured in the *Mittelstand*. China is already

the world's second-biggest exporter of such kit. With high labour costs at home, "innovation is our only competitive advantage", says Ulrich Ackermann of the VDMA, an association of machinery-makers. And that advantage is being eroded as more Chinese firms follow its electric-car industry in becoming more sophisticated.

German firms' relationship with China has therefore become "a constant walk on a tightrope between systemic competition and business partnerships", says Friedolin Strack of the BDI. No one believes in "political change through trade" in the foreseeable future, admits Wolfgang Niedermark, who until last year headed the German chamber of commerce in Hong Kong. But, it seems, German bosses still believe in trade, through all the political change. ■

### America v China Inc

## NYSE knowing you

NEW YORK

### A pall of uncertainty hangs over Chinese shares in America

THE TIES that bind the world's two biggest economies are unravelling, in fits and starts. The latest episode involved fits, starts and chaos. On December 31st the New York Stock Exchange (NYSE) announced that it would delist China Telecom, China Mobile and China Unicom, three telecoms giants, shares in which have been traded on Wall Street for years. It did so, it said, to comply with President Donald Trump's executive order in November banning American investments in companies with links to the People's Liberation Army (PLA).

This set off a fit among their American shareholders. As the trio's share prices swung wildly, funds scrambled to sell their stakes before the delisting, which the NYSE said would occur by January 11th. Specula-

tion raged that CNOOC and PetroChina, state-run energy goliaths also listed in New York, could be next. Then came the start. Late on January 4th the NYSE declared it would not eject the firms after all. Those same funds faced the prospect of repurchasing the shares, the price of which had popped up on news of the NYSE's U-turn. If that weren't chaotic enough, two days later the NYSE changed its mind again. It would, after all, boot out the three companies.

One thing is clear: Chinese companies listed in America face uncertain times. In December Mr Trump signed a bipartisan law that would expel from exchanges in America those companies that do not allow American regulators to audit their accounts, which is the case for many Chinese ones. On top of this law, Mr Trump's executive order is likely to remain a problem; Joe Biden may hesitate to rescind it after he takes office on January 20th. It affects more than 30 firms deemed too cosy with the PLA. To comply, FTSE Russell, which maintains global equity indices, plans to cut at least 11 Chinese technology firms from its roster. MSCI, a rival indexer, plans to boot ten Chinese firms from its benchmarks.

A rupture seems inevitable, then. How much will it matter? If it is limited to Chinese state-owned enterprises (SOEs), then not much. Only about a dozen SOEs trade in New York—and only thinly. Most have a more robust listing in Hong Kong or mainland China. Paul Gillis of Peking University argues that "it makes no sense for these companies to have US listings and be subject to US regulations".

That leaves two other potential casualties. If private-sector firms are included the number of Chinese firms listed in America swells to over 200, many of them in hot industries like technology and finance. Their combined market capitalisation exceeds \$2.2trn. Many may have links (however tenuous) with the PLA.

Losing access to America's sophisticated investors and deep pools of capital would sting such innovators as Lufax, a mainland fintech giant, which pulled off a \$2.4bn flotation in New York in late October. That risk is why Alibaba, China's e-commerce titan with a New York listing, hedged its bets in late 2019 by floating in Hong Kong as well. Others may follow.

American investors would suffer, too. Goldman Sachs, a bank, estimates that they hold 28% of the \$2.2trn in Chinese-linked market value in America. These stocks have outperformed the S&P 500 index of big American firms in recent years. Those with no secondary listing in China, which have most to lose from expulsion, have done even better (see chart). A hasty exodus by Chinese stars could force a fire sale. With Mr Biden unlikely to go easy on China, the most investors can hope for is more coherence—and fewer fits and starts. ■

### Red hot

Share prices, January 1st 2017=100



Sources: Bloomberg; Refinitiv Datastream

\*With market capitalisation above \$1bn at Jan 4th 2021

## Carmaking

## A Stellantis is born

## A long-awaited mega-merger may give rise to an industry star

FIAT CHRYSLER AUTOMOBILES (FCA), an Italian-American carmaker, and PSA Group, the French owner of Citroën and Peugeot, do not like to dwell on their shared past. When PSA acquired Chrysler Europe in 1978 for a nominal \$1 it picked up some struggling British and French marques and a heap of debt. That tie-up crashed a few years later with the demise of Talbot, the brand created from these motoring scraps. On January 4th shareholders of both firms voted to give it another go, acceding to a mega-merger agreed in 2019. Hopes seem higher this time. The name of the combined firm, Stellantis, is derived from the Latin for “brightens with stars”.

Stardust is sadly lacking from an industry that, along with many others, has taken a beating in the pandemic. But the creation of the world's fifth-largest carmaker by vehicles produced (see chart) is well set to deal with the effects of covid-19—and to navigate the other difficulties facing the automotive business.

The pandemic has sent screeching into reverse an industry that was already going backwards, as demand slumped in car-mad China. Annual worldwide sales fell from 94m units in 2017 to 90m in 2019. Covid-19 depressed sales by 15% in 2020, to 76.5m, according to IHS Markit, a data firm.

On the bright side, they are expected to rebound sharply this year. The signs are encouraging. Monthly Chinese sales have exceeded last year's in the second half of 2020. General Motors has led America's recovery, with sales up by 5% in the fourth quarter, year on year. And electric vehicles are booming, helping Tesla make good on Elon Musk's pre-pandemic forecast of delivering 500,000 cars in 2020.

Despite the rebound, the industry is not likely to get back to its size in 2019 before 2023. What does that mean for Stellantis (whose largest shareholder, Exor, part-owns *The Economist's* parent company)? Size will let it spread the costs of new technology. The savings, forecast at €5bn (\$6.2bn) a year, are more important than ever while the industry recovers. Cash reserves will be shored up by the decision of FCA's investors in September to accept a reduction in the special dividend that was part of the deal, by nearly half, to €2.9bn.

Stellantis also has Carlos Tavares. He has already turned round two loss-making firms: PSA, which he has led since 2014, and then Opel, acquired from General Motors

## Stellar or starry-eyed?

Vehicle sales, worldwide  
12 months to Q3 2020, m

Market capitalisation  
January 5th 2021, \$bn

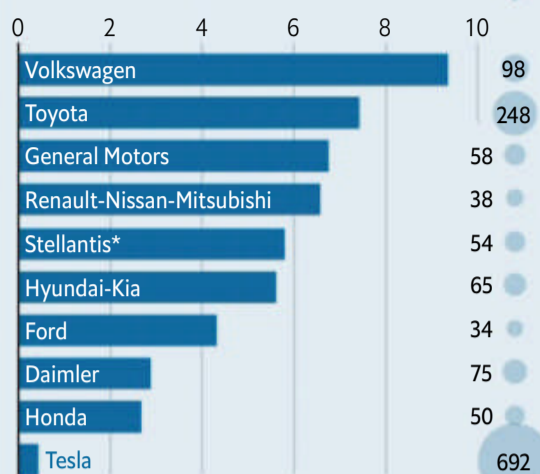

Source: Bloomberg

\*Based on current market value of Fiat Chrysler and PSA Group

in 2017. His task now is to revive the Fiat brand, which is dependent on Europe and was starved of investment after the merger with Chrysler in 2014. Only the ageing 500 supermini is selling well.

The reticence of both Mr Tavares and Sergio Marchionne, FCA's late boss, to rush headlong into electrification may also prove wise. Other carmakers had poured

cash into electric cars that did not sell well. Now that they are becoming more popular, Stellantis's plans, including PSA's new architecture for electric vehicles due by 2023, have more chance of success.

The deal also affords the opportunity to reset strategy, says Jefferies, a bank. The firms are strong regionally, PSA in Europe and FCA in America, but lack global clout. Neither has much presence in China. And in an industry where complexity is now a dirty word, Stellantis will have 15 brands. Volkswagen's 11 are seen as unwieldy.

Mr Tavares needs to make Jeep a worldwide profit machine like vw's Audi and Porsche, and to decide what to do about underperforming premium brands. Maserati and Alfa Romeo have defied numerous relaunches to stay peripheral. DS is profitable but has little presence outside France.

Stellantis's boss must also overcome the clashes of culture that have brought down many a car-industry merger. Marchionne made FCA work through force of personality and the width of the Atlantic, which let him keep the subsidiaries at arm's length. Mr Tavares does not have that luxury, or Marchionne's charisma. But his stellar track record shows he has the character to make it happen. ■

## Roaring '20

## Global M&amp;A deal value by sector, \$trn

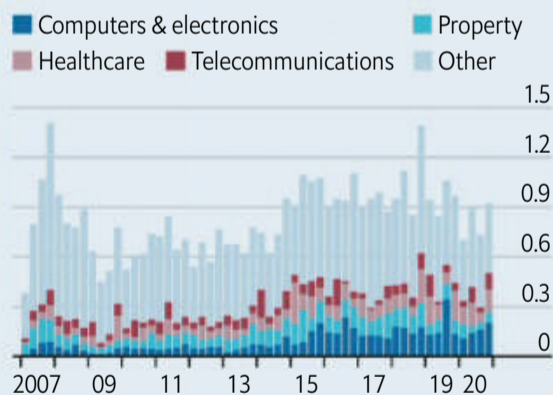

## Biggest M&amp;A deals, 2020, \$bn

Company	Buyer	Date	\$bn
IHS Markit	S&P Global	Nov 30th	43.5
NTT DoCoMo	NTT	Sep 28th	40.3
Alexion Pharma	AstraZeneca	Dec 12th	39.1
ARM	Nvidia	Sep 13th	34.5
Xilinx	AMD	Oct 27th	32.7
Willis Towers Watson	Aon	Mar 9th	31.4
Slack Technologies	Salesforce	Dec 1st	25.8

Sources: Dealogic; Bloomberg; press reports

## Global M&amp;A activity by nationality\*, Q4 2020, \$bn

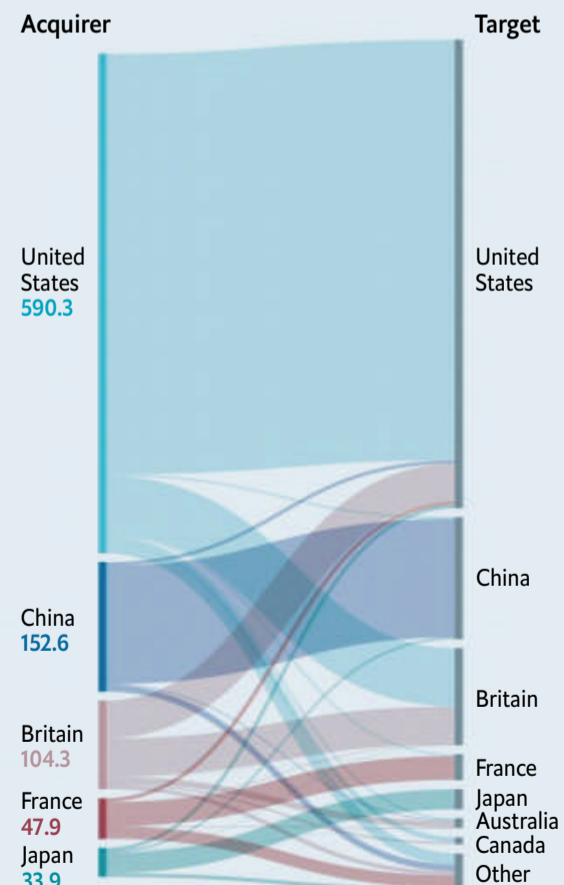

\*For top ten target countries

## Rekindling corporate nuptials

After a pandemic lull, \$900bn-worth of deals were announced in late 2020. This year got off to a hot start, with MGM Resorts' \$11bn bid for Entain, a British betting-shop operator, and a potential \$18bn tie-up of Gojek and Tokopedia, two Indonesian tech darlings.



## Oil exploration

## Thanks, but no thanks

NEW YORK

Energy companies give the Arctic the cold shoulder

TO THE GWICH'IN people, the coastal plain of the Arctic National Wildlife Refuge in Alaska is "the sacred place where life begins". To environmental campaigners, it is a rare habitat that must remain protected, home to caribou, polar bears and migratory birds from six continents. To President Donald Trump, it is a promising source of oil wealth and American energy security. To energy companies, it is a risk not worth taking.

On January 6th, after four decades of fighting over whether to allow drilling in the refuge, the federal Bureau of Land Management (BLM) held an auction for oil leases on the coastal plain. The state of Alaska and two small local companies were the only bidders—offering just \$14.4m for about half of the more than 1m acres for sale—with the state hoping to find an oil company to drill in future.

It is a fitting final chapter in Mr Trump's campaign to unleash drilling on federal lands, characterised by maximum bravura and mixed corporate impact. Companies have happily poured capital into areas with low costs and ample reserves. Chevron, Occidental and Concho Resources, to name a few, have invested in federal property in New Mexico, home to part of the rich Permian shale basin. Joe Biden has said he would ban new permits, prompting firms to secure acreage before he takes office on January 20th. The number of new permits on federal lands was 52% higher in 2020 compared with 2019, according to Enverus, a research firm. New Mexico was abuzz with activity.

Yet broader interest in Mr Trump's auctions has been lukewarm. Even before covid-19 rocked the energy industry, poor performance was prompting executives to become choosier about new projects. When they do invest, says Artem Abramov of Rystad Energy, another research firm, "the industry has very little interest in new conventional projects that are unproven."

That has helped ensure that many federal lands remain untapped, despite Mr Trump's best efforts. During his presidency the BLM has offered more than 25m acres of onshore public lands for oil and gas leasing, according to the Centre for Western Priorities, a conservation group. Only 22% of those acres have found takers. Of these, a fifth have been purchased at \$2 an acre.

Mr Trump's enthusiasm for Arctic drilling is matched by that of Alaska's Republi-



Free to roam, as the majors migrate south

can senators and allies in Congress. The tax reform of 2017 required two big auctions of leases in the refuge within seven years, with the first mandated by late 2021. Even so, the industry's appetite for Alaskan projects, even outside the refuge, has been weak. Many big companies had lost interest in the state well before the pandemic, lured by cheaper prospects elsewhere. Last year BP, a British energy giant, sold its Alaskan assets to Hilcorp, a smaller private company. Alaska's oil production in 2019 was less than a quarter of its level in 1988.

To an oil executive deciding how to allocate a limited capital budget, the refuge itself looks as appetising as a rancid stew doused with arsenic. Estimates for the refuge's reserves range wildly, from 4.3bn barrels to 11.8bn. "We don't know the size of the resource, the cost is uncertain and the regulatory framework is uncertain," notes Devin McDermott of Morgan Stanley, a bank.

Less in doubt is that litigation will continue. On January 5th a federal judge rejected an effort by native Alaskans, the Natural Resources Defence Council, the National Audubon Society and other NGOs to halt the auction. But broader legal challenges will drag on. Banks including Goldman Sachs and JPMorgan Chase have vowed not to lend to any oil project in the refuge. Mr Biden opposes drilling there and could obstruct development. If his efforts fail, lease-holders will have paid a low price. Bids averaged less than \$26 an acre, barely above the BLM's minimum of \$25. Mr Trump's pursuit of energy dominance would then have a characteristically strange postscript: America's most pristine natural habitat, sold for a song. ■

## Corporate charity

## Giving and taking

The unintended consequences of forcing firms to back good causes

KITEX GARMENTS is one of the largest private companies in Kerala, a communist-led state in southern India. Its embrace of corporate social responsibility (CSR) is enthusiastic. In the fiscal year ending in March 2020 it allocated 5.3% of its average profit over the past three years to public roads, schools, housing and safe drinking water. That makes it a poster-child for an Indian law passed in 2013, in the aftermath of a corporate fraud scandal, that requires Indian companies to divert at least 2% of annual profits to CSR projects.

Arguments leading up to the law's approval pitted NGOs and populist politicians, who supported it, against India Inc, which said it merely created a new tax. Several big corporate contributors argued that philanthropy would be damaged by government involvement. A new study by Shivaram Rajgopal of Columbia Business School and Prasanna Tantri of the Indian School of Business suggests that last group has a point.

The researchers sifted through the filings of 39,000 companies to see how behaviour changed. Advocates of the law will be pleased to see that the sum the average company channelled annually to CSR efforts rose slightly in fiscal 2014-19, compared with 2009-14. It was not, however, an unalloyed triumph. Kitex, with its consistently high charitable contributions, turns out to be an exception.

Of the 2,152 companies that gave more than 5% of profits before the law went through, average real contributions fell by half (see chart). In place of spending on social causes, Mr Rajgopal and Ms Tantri found increased spending on advertising. ▶▶

## Do-gooding less with more

India, corporate-social-responsibility spending\*  
Annual average per company by category, rupees m

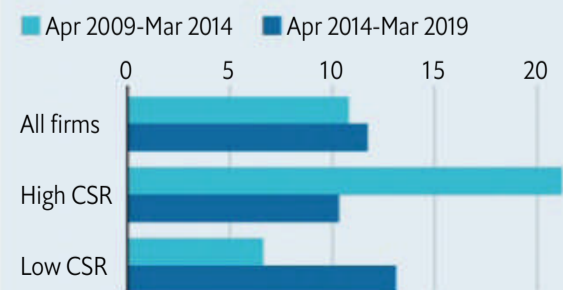

\*At 2010 prices

Source: "Does mandated corporate social responsibility crowd out voluntary corporate social responsibility? Evidence from India", by S. Rajgopal & P. Tantri, Columbia Business School & Indian School of Business, Dec 2020

▶ Economists studying CSR spending posit three possible incentives for it: genuine altruism; private interests of managers who enhance their own position with corporate cash; and improved performance and valuations as a consequence of a burished reputation among customers and better morale among employees.

If the first two were at work, Mr Rajgopal and Ms Tantri speculate, India's biggest spenders would not have cut back: setting a minimum payment would impede neither altruism nor benefits to managers. Instead, the reduced payments suggest that past

spending was mostly about "signalling value". Once they became obligatory, CSR payments were seen as merely another component of regulatory compliance. Or, as Mr Rajgopal concludes, "The halo was lost."

The question left open by the study is where CSR money goes and whether that too has been affected by the law. Many Indian businesses are family-controlled. Their CSR contributions often go from the companies to charitable entities also controlled by the families. India's largest company, Reliance Industries, for example, directed 94% of its 2019 contributions to

the Reliance Foundation, chaired by Nita Ambani, the wife of Mukesh Ambani, Reliance's largest shareholder and boss. To its credit, Reliance discloses these contributions. Many others are less forthcoming.

Where CSR money ultimately ends up is often unclear. Some may flow into India's political system. Kitex is again the exception. The company's allied do-gooding arm is quite transparent about supporting political candidates and has spoken out about its efforts to do so in response to past government failures. This, it would argue, is the socially responsible thing to do. ■

## Bartleby Network effects

*The modern economy depends on how well people connect with others*

**S**UCCESS IN MANUFACTURING depends on physical things: creating the best product using the best equipment with components assembled in the most efficient way. Success in the service economy is dependent on the human element: picking the right staff members and motivating them correctly. If manufacturing is akin to science, then services are more like the arts.

Motivating people has an extra complexity. Widgets do not know when they are being manipulated. Workers make connections with their colleagues, for social or work reasons, which the management might not have anticipated.

Marissa King is professor of organisational behaviour at the Yale School of Management, where she tries to make sense of these networks. She attempts a classification in her new book, "Social Chemistry: Decoding The Elements of Human Connection".

The term "networking" has developed unfortunate connotations, suggesting the kind of person who sucks up to senior staff and ignores colleagues who are unlikely to help them win promotion. Ms King cites a study which found that two-thirds of newly promoted professionals were ambivalent about, or completely resistant to, thinking strategically about their social relationships.

From the point of view of productivity, the most important networks are those formed by employees from different parts of the company. Diverse viewpoints should lead to greater creativity. They are good for workers, too. A study found that catching up with colleagues in different departments was linked to salary growth and employee satisfaction.

Some employers had the bright idea of encouraging this co-operation by moving to open-plan offices. But re-

search suggests that workers in open-plan layouts are less productive, less creative and less motivated than those in offices with a traditional, room-based design. The quality of interactions is more important than the quantity. The pandemic, by forcing many people to toil away at home, has probably corroded some of these co-operative arrangements.

Ms King says that people tend to construct three types of network. "Expansionists" have a wide set of contacts but their relationships tend to be shallow. "Conveners" have a small number of relationships, but these are more intense. "Brokers" link people from different network types.

On the surface, this categorisation seems reasonable. How useful is it? Readers can take an online test (at [assessyournetwork.com](http://assessyournetwork.com)) to see which category they fall into. Bartleby did so and found (as he expected) that he did not fit into any of them. Indeed, the author's research shows that one in three people does not have a clearly defined style and 20-25% could be classed as mixed (for example, they are simultaneously brokers and expansion-

ists). In other words, more than half of people cannot be neatly categorised.

To add to the muddle, Ms King introduces sub-categories: co-operative brokers, arbitrating brokers, tortured brokers, and so on. Some people move from one category to another (like a certain Heidi Roizen, who, in a feat of management jargon, "transitioned from an expansionist to a broker to a convening nucleus"). At this point it seems wiser to admit that, to use an old phrase from the north of England, "there's nowt so queer as folk". Fortunately, the book is full of wisdom and entertaining anecdotes which show that stories can give more insight than attempts at scientific categorisation.

Two fun case studies outline a common problem—the tendency for people to have too narrow a focus. In one test, only one in four mobile-phone users noticed a clown who unicycled past them while they were looking at their screens. In another revealing story, Catholic seminarians strode past a distressed bystander while in a hurry to give a lecture on the parable of the good Samaritan. In the right network, the presence of a diverse set of participants may allow the group to see the bigger picture.

Old-fashioned concepts like courtesy can also help, Ms King argues. Simple gestures—a smile, a thank you—make colleagues more likeable and increase co-operation. In contrast, studies of workers who experience incivility find that their effort, time spent at work and commitment to the job all reduce. Ms King invokes the aphorism that "assholes" can be identified by observing how they treat people with less power. "Don't be an asshole" is not a scientific statement. But it is still a pretty good management motto.





# Schumpeter | The game goes on

*A leaked memo to Tex A. Voyda, a tech boss, from his firm's tax consultant*



**T**HANKS FOR contacting me for an update on the international corporate-tax landscape. For global tech firms like yours, the headlines make worrying reading. A fragile transatlantic truce has been shattered. France has resumed collecting the digital-services tax it introduced in 2019, targeting tech firms (and catching others in the net). The outgoing Trump administration has lined up retaliatory tariffs on \$1.3bn of posh French handbags, cosmetics and more, ready to pull the trigger. If America acts, the European Union may strike back against American products of equivalent value.

America complains that national tech taxes unfairly target its digital giants. It had better get used to them. Such levies, typically 2-3% of local sales, are spreading as governments try to claw back taxing rights lost in a dysfunctional global system. Among those joining France in implementing or mulling a digital tax are Brazil, Britain, India and Italy. An EU-wide version has been mooted.

You don't need me to tell you that this is just one front on which big tech is being assailed, alongside alleged anticompetitive behaviour, the handling of user data and the policing of speech. Employees are growing restless, too. I imagine you saw this week's news from across town about Alphabet's geeks forming a union.

Amid this onslaught, it is worth keeping a sense of perspective. The winds on tax are shifting from favourable to, with luck, no worse than fair. We are coming off a golden age for tax-minimisation. Breakneck globalisation allowed multinationals to replace fears of double taxation with the joys of double non-taxation, using tax havens to game the system. By exploiting mismatches between different countries' tax laws, taxable profits could be made to vanish. No wonder corporate tax departments swelled, as more brainboxes were hired to find loopholes. You have enough tax lawyers these days to fill a small concert hall (were that allowed). You and other tech firms were some of the craftiest innovators: the five largest Silicon Valley giants paid \$220bn in cash taxes over the past decade, or just 16% of their cumulative pre-tax profits.

This era could not last for ever. Already, some tax gymnastics are no longer possible, owing to a multilateral clampdown brokered by the OECD club of industrialised countries after the global financial crisis. The "Double Irish with a Dutch Sandwich", a popular dish that channelled profits through EU-based shell subsid-

aries to a tax haven like Bermuda, is off the menu. So are "hybrid mismatches", whereby differences in two or more countries' treatment of an instrument or type of entity could be exploited to magic away taxable income or create a long-term tax deferral. The most egregious tricks involving intra-company loans have also been snuffed out. Governments, especially in Europe, have grown teeth in going after what they perceive as aggressive avoidance; Apple, don't forget, is still tussling with Brussels over a \$16bn back-tax demand. And now Facebook reportedly wants to close its Irish holding companies.

That still leaves plenty of scope to bring down tax bills, in particular through creative use of intangible assets, such as patents and other intellectual property. Balance-sheets of digitally focused firms like yours are stuffed with these. The tax-free route via the Caribbean has grown trickier, but you can still get the rate down to single figures using the EU's haven-lites, including Ireland and Luxembourg. Governments, including in Europe, that have excoriated tax-shy firms in public have been quietly cooking up new schemes to attract investment, such as "patent boxes".

Better still, "transfer pricing" also remains largely intact. It has underpinned global tax policy for decades, allowing firms to move profits to lower-tax territories by, in essence, pretending that their subsidiaries deal with each other at arm's length. From the (patchy) data available, the amount of profits being shifted around hasn't fallen much. According to the Tax Justice Network, a pesky NGO with gratingly solid number-crunchers, multinationals continue to short-change governments by around \$250bn a year.

Covid-19 is a worry, to be sure. The huge holes it has blown in budgets could send people reaching for the pitchforks, demanding all pay their "fair share". And what better target than the tech giants that have "made out like bandits" in the pandemic? Reflecting the mood, some countries have banned firms registered in tax havens from receiving bail-out funds. Self-styled tax-fairness campaigners have been throwing emotionally charged statistics around, for instance that the lost \$250bn is equivalent to 20m nurses' salaries.

With risks growing, you may want to wrest control of this issue personally from your tax department, which cannot see the pitchforks for the profit. You should lobby for a multilateral, OECD-led deal. Why? For starters, big tech could do with an armistice in at least one of its global battles with regulators—and the antitrust and data dust-ups will grind on relentlessly for years.

## **Yours, Lou Pohl**

As important, a global deal is the least bad option for business. It would bring in a minimum global tax rate, but the bar is likely to be set low, at perhaps 12.5% of profits—below the average cash-tax rate you actually pay as a big American tech firm these days. The deal's other pillar—making digital firms liable for tax in markets where they have customers but lack a physical presence—will make you twitchier. But even its champions accept it is unlikely to skim more than \$5bn-10bn in extra revenue globally once all the horse-trading is done. Much will depend on the incoming Biden administration, which has yet to signal its intentions.

Unless it does, and soon, a draft accord by mid-2021 looks optimistic. Push for it nonetheless. The alternative looks ugly: a global tax tit-for-tat as national tech levies of varying severity become the norm, with overlapping tax claims and a possible return to pre-globalisation double taxation. So back a global deal, and trust that it will be relatively modest. The rules of the tax-avoidance game may be changing. But there's still a game. ■



# World Trade Symposium

February 2021

February 2nd–4th 2021 | Virtual event

## A global trade resurgence?

Covid-19, protectionism and global tensions have had an impact on trade like never before. Amid the crisis there is a unique opportunity to rebuild an inclusive and prosperous trade ecosystem that benefits all. Hear from leaders in government and business and assess the future of sustainable trade.

Speakers include:



**Stefano Pessina**  
Chief executive officer  
Walgreens Boots Alliance



**Audrey Tang**  
Digital minister  
Taiwan



**Hai Tai-Tang**  
Chief product platform and  
chief operations officer  
Ford



**Vera Songwe**  
United Nations under secretary-  
general and executive secretary of the  
UN Economic Commission for Africa



**Register free**  
[worldtradesymposium.com](https://worldtradesymposium.com)

HOSTED BY



PROGRAMMED BY



GOLD SPONSORS





# A commission-free trade is only as **smart** as you are.

Now that commission-free trading is the norm, it's time to rethink how we define value. That's why, along with \$0 online equity commissions,\* we offer personalized education to sharpen your skills, a trader support team trained to answer any question, and powerful charting and analysis capabilities on thinkorswim®.

Bottom line: real value comes from everything TD Ameritrade offers to make you an even smarter trader.

Discover true value at [tdameritrade.com/value](https://tdameritrade.com/value)



Where Smart Investors Get Smarter<sup>SM</sup>

\*Applies to U.S. exchange-listed stocks, ETFs, and options. A \$0.65 per contract fee applies for options trades.  
TD Ameritrade, Inc., member FINRA/SIPC. © 2020 TD Ameritrade.



→ Also in this section

- 62 Buttonwood: Equity valuations
- 63 Bitcoin zooms
- 64 Divining water risk
- 64 Company delistings in China
- 65 Counting the cost of covid-19
- 66 Free exchange: Rethinking welfare

The markets in 2021

# Melting up

## Why the crazy upward march in stock prices might just continue

IN A FAST-CHANGING world, the investment bankers of Wall Street and the City of London have clung to certain rituals. One of these is the annual “outlook”, which lays out the path the economy and financial markets might take over the coming year. These hefty documents start to appear in inboxes a few weeks before the year’s end.

In mid-November a strategist at one bank had just put his outlook to bed with satisfaction. His call on stocks for 2021 was “constructive”: Wall-Street-speak for “bullish, but not mindlessly so”. But a few days later he was feeling a little less pleased with himself. His outlook was not distinctive. Rival strategists too were constructive.

It is not hard to see why. An end to the covid-19 pandemic is in sight. Rich-world governments are rediscovering the joys of fiscal pump-priming. Real interest rates are so low as to make sky-high stocks look cheap (see Buttonwood). In short, the conditions seem ripe for further stockmarket gains. So ripe, indeed, that a persistent

thought keeps surfacing in the minds of strategists. What is to stop stock prices worldwide going on a really crazy run?

Several things could get in the way of a market melt-up. One is the economy. Since April markets have been looking beyond the damage from covid-19 to the post-pan-

demical recovery. The discovery of workable vaccines seemed to bring that world closer. Economic indicators for America and China towards the end of 2020 were surprisingly strong. But the pandemic is not going quietly. More virulent strains of covid-19 have forced stricter lockdowns in parts of Europe. The harm to the world economy is likely to be more prolonged than hoped.

Another obstacle is bullish sentiment. The last time fund managers were this optimistic about the scope for stockmarket gains was January 2018, according to a monthly survey by Bank of America done in December. A large majority think the world economy is in the “early-cycle” phase (ie, that there is a long runway of ▶▶

### The warm-up act

Total returns, 2020, %



Sources: Refinitiv Datastream; Bloomberg; The Economist

### US corporate bonds with a BBB rating

Spread over Treasuries, percentage points

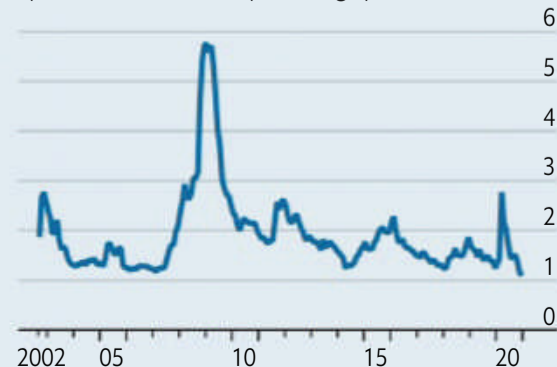



▶ growth ahead). Paradoxically, positive sentiment is often seen as a reason to be wary, and that investors have got ahead of themselves. Indeed, 2018 began with much talk of a market melt-up, but ended with heavy stockmarket losses.

A lot of the current optimism rests on the idea that policy will continue to support the economy. What if policymakers change tack? Continued fiscal support requires political action and agreement, which cannot always be relied upon. A natural concern is that stimulus might be withdrawn abruptly, as it was after 2010. So

far, though, there is little sign of this. In America the \$900bn fiscal package passed after Christmas will add two percentage points to GDP growth in 2021, reckon economists at JPMorgan Chase, a bank. The loss of the Republican majority in the Senate may open the door to further fiscal easing. In Europe the boost from the €750bn (\$920bn) recovery fund should start to be felt from the middle of the year.

Yet another risk, and one that keeps some market bulls awake at night, is resurgent inflation. Lockdowns and fiscal transfers have left rich-world consumers with

extra savings and a lot of pent-up demand—fuel for a post-pandemic spending spree. Meanwhile recession has also taken out supply capacity: a lot of small firms (and some large ones) have gone under. With enough bottlenecks, a surge in spending could drive up inflation. A dynamic of this kind has been playing out in commodity markets: a revival in industrial demand (notably from China) for copper and iron ore has bumped up against supply constraints and led to a run-up in prices.

A temporary bout of inflation seems plausible. A sustained burst of higher infla- ▶▶

## Buttonwood The lion sleeps tonight

*Stocks are still cheap relative to bonds*

**B**ILLY CONNOLLY, the great Scottish comedian who recently retired from performing, had a joke about two men filming a lion for a wildlife documentary. The lion suddenly looks up. The men fear they have been spotted. One of them slowly removes his boots and puts on a pair of running shoes. “You will never outrun a lion in those,” says his colleague. “I don’t need to outrun the lion,” replies the first man as he slowly ties his shoelaces. “I just need to outrun you.”

The joke rather neatly captures a particular approach to investing. What matters is not so much whether you can get ahead of some absolute goal for returns. The important thing is whether the asset you choose to invest in will comfortably beat the alternatives.

Share prices in America are at all-time highs. The cyclically adjusted price-earnings (CAPE) ratio, a measure of value popularised by Robert Shiller of Yale University, has only twice been higher than it is now—in the late 1920s and the early 2000s. Yet a recent study by Mr Shiller, Laurence Black and Farouk Jivraj suggests that today’s steep stock prices may still be warranted, because interest rates are so low. Indeed, compared with the real yields offered on risk-free government bonds, equity prices have plenty of appeal. Equities do not have to beat their historical returns to be worth holding, it would seem. They just need to outrun bonds by a decent margin.

A key strut to this thinking is that the earnings yield—the inverse of the price-earnings ratio—is a decent forecast of expected returns on equities. An empirical study in 1988 by Mr Shiller and John Campbell found that yields on equities help predict long-term returns. The dividend yield (ie, the dividend-to-price ratio) and three different measures of

earnings yield all show some forecasting power, which is to say they explain at least some of the variation in future returns. The longer the horizon over which returns are measured, the better the prediction. And the best measure to use is an average of a few years of earnings, because profits are noisy from one year to the next. The use of an average of recent earnings goes back at least to Benjamin Graham, a pioneer of stock valuation. Mr Shiller’s CAPE is simply an extension of this approach.

The intuition behind the predictive relationship is straightforward. If stock prices are high relative to a measure of fundamental value, such as earnings, then subsequent returns tend to be low, and vice versa. A low earnings yield implies that investors are willing, at that point in time, to accept puny returns in the future. If you think this is trivial, consider the following. Low yields might instead be a forecast of bumper corporate profits. But they are not. This yields-predicts-returns analysis applies to assets other than equities, according to “Discount Rates” (2011), a panoramic survey by John Cochrane of the

University of Chicago’s Booth School of Business. High house prices relative to rents signal low returns, not rising rents. Credit spreads on bonds are a signal of returns, not default probabilities.

All else being equal, you should be less keen to hold equities (or keener to hold fewer equities) the lower the earnings yield is. But not everything else is equal. The price of assets should equal expected cashflows discounted over the life of the asset. The earnings yield gives you the “expected” part of this equation; real bond yields cover the “discounted” part. The gap between these two is a forward-looking measure of the equity risk premium, the excess return for holding shares.

The chart shows a crude measure of this risk premium. It varies over time in large part because risk appetite varies over time. Although it has been higher in the past, it is not obviously low now. In the 1990s, during the dotcom boom, the premium for owning stocks was negative—real interest rates were a handsome 4%. Now real rates are negative. It is not hard to outrun that sort of yield. Mr Shiller and his colleagues use a similar measure, based on CAPE yields, and extend it to stockmarkets other than America’s. Their conclusion is that, despite high prices, equities are attractively priced relative to bonds—even in America, but more so in Britain, the rest of Europe and Japan.

A jump in real long-term interest rates worldwide would upset the whole constellation of high asset prices. It is hard to be confident that this is forthcoming. In an ideal world for investors, expected returns on all assets would be better. But we are where we are. If you can’t outrun the lion, perhaps all you can do is to try to outrun the other guy.

### Changing appetites

United States, equity risk premium\*  
Percentage points

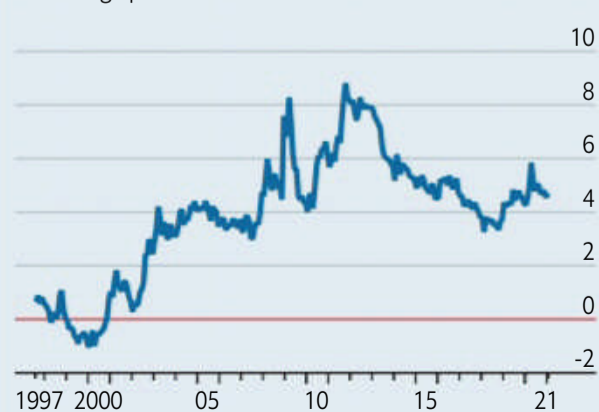

Source: Refinitiv Datastream

\*Gap between S&P 500 forward earnings yield and real five-year Treasury yields

tion—and one that forces central banks into abruptly raising interest rates—appears less so. Nor is it obvious that bond markets will react so violently as to fatally undermine stock prices. Bond yields have been edging up for months: this week the ten-year Treasury yield exceeded 1% for the first time since March 2020. This upward creep does reflect higher market expectations of inflation, which are now above 2% in America. But yields on inflation-protected Treasuries have barely budged—and it is these real yields that are the benchmark for stockmarket valuations. If the pattern of modestly above-target inflation expectations, a relaxed Federal Reserve and steady real yields stays intact, it may well boost equity prices, not retard them.

There are other hangover effects from the pandemic to consider. A big one is debt. Companies borrowed heavily to ensure they had enough cash to withstand the revenue losses from lockdowns. The increased debt load will drag on companies' finances and could in turn weigh on equity prices. But it may not be a heavy weight. Central-bank buying of corporate bonds has kept financing costs remarkably low for companies with access to wholesale capital markets: just consider the cost of borrowing for companies with debt rated BBB, the riskiest investment-grade rating. The spread over Treasuries is about as low as it was in 2006, when wider credit conditions were dangerously easy. Such low borrowing costs make debt burdens easier to carry. A related concern is that the explosion in public debt will eventually push up real interest rates. But demand for liquid safe assets tends to stay high after crises. Chief among these are government bonds.

On a closer look, then, many of the obstacles to the stockmarket's upward march do not seem so formidable. A terrible year for the economy still produced positive returns in many stockmarkets. The fact that recession has hurt small unlisted businesses more than large listed firms is one part of the story. The other is the paucity of yields on offer from bonds. In a note this week Jeremy Grantham, co-founder of GMO, an asset manager, argues that stocks in America have already gone too far. "My best guess as to the longest this bubble might survive is the late spring or early summer," he writes, and advises seeking refuge in cheap emerging-market stocks.

Mr Grantham's note is well worth reading. But a thought lingers. The case for owning stocks at these prices depends on low interest rates. This is a global condition. So why would stock prices not melt up elsewhere? Perhaps Wall Street's year-ahead notes for 2022 will survey the wreckage of a stockmarket bust in America. But it seems as plausible that strategists will be cheering on prices from higher peaks—constructively, of course. ■

## Bitcoin zooms

# Crypto-conversion

## Is the financial establishment coming round to bitcoin?

**T**WELVE YEARS ago, on January 3rd 2009, a headline on the front page of the *Times* read: "Chancellor on brink of second bail-out for banks"—a reference to the British government's efforts to save the country's financial system from collapse. When Satoshi Nakamoto, the mysterious inventor of bitcoin, created the first 50 coins, now called the "genesis block", he permanently embedded the date and that headline into the data. The hidden text was a digital battle cry. Mr Nakamoto had decided it was time for something new: a decentralised cryptocurrency, free from the control of governments and central banks.

Mr Nakamoto has vanished from public view, but his invention has gained prominence—and lately has been soaring in value, too. It first gained widespread attention in 2013 as a financial curiosity, when its price climbed above a then giddy-looking \$1,000. In 2017, in a frenzy of speculation, the price spiked just shy of \$20,000, but then quickly plummeted. As recently as October 2020 it was worth only \$10,600. But then it began to climb again, passing its old peak on December 17th and ascending to a new high, above \$36,000, on January 6th (see chart).

Over the years bitcoin has spawned an entire ecosystem, including lots of copycat tokens, such as Ether; and several exchanges to trade cryptocurrencies, such as Coinbase, founded in 2012. Many have dismissed investing in it as a pursuit for those on the financial (or even legal) fringe. Bitcoin is no stranger to scandal: in 2014, for instance, Mt Gox, another exchange, collapsed after a hoard of tokens was stolen.

Unlike the last occasion when prices



were rocketing, the current surge seems to have been spurred by interest from the financial establishment, most of which had long scorned it. Paul Tudor Jones of Tudor Investments, which manages \$38bn, has said one of his funds could increase its bitcoin position to as much as a "low single digit" percentage of its assets. Bill Miller of Miller Value Partners has remarked that the chance of the token's value falling to zero is "lower than it had ever been". Stanley Druckenmiller, a former protégé of George Soros, has also warmed to the idea of using bitcoin as a hedge in place of gold, which is often used as a financial bet on anarchy, or against inflation. On December 17th Coinbase filed to go public. A long-predicted bitcoin exchange-traded fund (ETF) may at last come to fruition in 2021.

If some portfolio managers have come round to investing in bitcoin, its value could climb further—or, at least, there could be a floor to it. If the masses pile in through an ETF, that would also maintain demand. But other investors, such as the managers of huge pension funds, are likely to keep steering clear. They typically invest in things that generate reliable future cash-flows, like bonds or stocks, and tend to shy away from things that don't, such as gold, other commodities—and bitcoin.

Bitcoin was conceived as a currency, for payments and transactions. For that it would need to be stable and easy to use. Yet Mr Druckenmiller likes bitcoin because it is precisely the opposite: thinly traded and thus less liquid and more volatile than gold. It is increasingly treated by those who buy and sell it, and by regulators, as an investment. It may be good news for those holding bitcoin that others are piling in, but speculators' enthusiasm suggests that cryptocurrencies will fall far short of their founders' lofty aspirations. ■

### A wild ride

Bitcoin price, \$'000



Source: CoinDesk



## Divining water risk

## An expanding pool

## Whizzy methods help investors spot water risk

FROM A SMALL office in Montreal an artificial-intelligence business, Aquantix, plays sleuth for faraway investors worried about water risk. Its model combines high-resolution satellite imagery, weather-station data and regulatory documents scraped from the internet. It estimates not only how much water a business uses at its various sites but its water bill, the chances of drought or flooding in surrounding areas and the financial impact such disasters could have—all without contacting the company in question.

Firms like Aquantix are proving useful to investors waking up to water risk. At current rates of consumption, the demand for water worldwide will be 40% greater than its supply by 2030, according to the UN. Portfolio managers are realising that physical, reputational and regulatory water risk could hurt their investments, particularly in thirsty industries such as food, mining, textiles and utilities.

One worry is that shocks to supply could drown or dry out a company's assets. In recent years Coca-Cola has been forced to close plants in India because of drought. In 2019 floods in America's Midwest caused disruptions at the facilities of two food giants, Cargill and Tyson Foods. A survey by CDP, a non-profit firm, found that 783 big listed companies had faced a total of \$40bn of water-related losses in 2018.

Another concern is that the price a com-

pany pays for water could rocket. The market price of water does not reflect the environmental and social costs of using it. Government subsidies also mean that companies often do not pay for its true cost. As aquifers are depleted, though, subsidies could become more costly and unpopular, forcing governments to retract them. S&P Global Trucost, a data provider, reckons that if Fortune 500 companies paid the true cost of water, based on estimates of scarcity, rather than current prices, their profit margins would shrink by a tenth. Margins for food, drink and tobacco firms would fall by three-quarters.

Disclosures of water risk are even patchier than those of greenhouse-gas emissions. In part, that is because it is more difficult to measure. Emitting a tonne of carbon dioxide in the Sahara or in London has the same environmental impact. Using a gallon of water does not. Place-specific data can be commercially sensitive and difficult to aggregate. So businesses resort to vague global estimates instead.

Unlike emissions, however, water can be observed, and third-party data providers can have a crack at estimating a company's water use. Established names like Bloomberg and S&P Global are plugging the gap, as are startups. The result, says Toby Messier, co-founder of Aquantix, is that investors can approach management armed with data rather than questions. "We are

getting rid of the black box that companies hide in," he says.

Investors can turn to a range of new methods. Some want a simple score to plug into a model. Ceres, a non-profit firm, scores businesses on everything from direct water management to risks in the supply chain. Those seeking more detail can use visual tools, such as Bloomberg's "maps" function, which plots a company's facilities over a heat map based on water stress. (California is the same colour as swathes of sub-Saharan Africa; far-eastern Russia looks a lot like western Europe.) Firms like Aquantix go further, and try to predict the financial cost of water risk.

The accuracy of such forecasts is not yet proven. For Andrew Mason of Aberdeen Standard Investments, though, they are still useful. They show companies that investors care about water risk and encourage them to share data. "This is where carbon was ten or 15 years ago," he says. ■

## China's stockmarket

## Bring out your dead

SHANGHAI

## China wants to clear the dross from its stock exchanges

LIKE MANY Chinese companies on the stockmarket, Gangtai Holding, a jewellery-to-property conglomerate, flaunts its listing. It displays its ticker number, 600687, prominently on its website and in its ads. But not for much longer. On January 7th Gangtai began a 30-day period almost certain to end with its ejection from the Shanghai Stock Exchange. It is one of a growing number of Chinese companies to face delisting at home.

In recent months all the delisting talk has been about the removal—or not—of Chinese companies from American exchanges (see Business section). Within China, though, a potentially more important kind of delisting is on the agenda: regulators have made it easier to strip lousy firms of their listing status. It is the latest in an array of reforms aimed at modernising the stockmarket, long seen more as a casino than an efficient allocator of capital.

Delistings are a staple of healthy stock exchanges, a mechanism for clearing out the dross. In America a few dozen companies are typically forced off its exchanges every year, often because of low market values. In the early 2000s, after the dotcom bust, annual delistings climbed to nearly 400. China, by contrast, has averaged seven delistings a year over the past decade, despite having more than 4,000 listed companies, nearly as many as America. ▶



Navigating risky waters

**Down and out**China, stockmarket indices  
January 2nd 2014=100

Delistings have been so infrequent in China mainly because, relative to demand, listings themselves were hard to come by. “Even if a company is nearly bankrupt, the shell value of being listed is really high. Just by staying alive it can find a buyer,” says Lu Fangzhou of the University of Hong Kong. This has made for perverse incentives. Listed firms in financial trouble in China are classified as “special treatment”, abbreviated to ST before their ticker name, to warn off investors. Instead, however, it is often an invitation to bid up their prices, as buyers might emerge. ST stocks are volatile, but their returns have occasionally beaten the overall market (see chart).

That has recently begun to change. Regulators relaxed controls over initial public offerings, paving the way for hundreds of new listings. The value of being a shell diminished. The delisting reform, introduced on the final day of 2020, attacks the problem from the other end. Companies with share prices below 1 yuan (\$0.15) for 20 consecutive days will now face automatic delisting. Those that fraudulently overstate their earnings by 100% for three years are on the chopping block, too.

The process will also become much faster, eliminating an intervening trading suspension—when troubled companies could find buyers. China’s delistings could increase to about 50 a year. Some investors complain the rules are still too lenient. For example, Luckin Coffee, a Chinese would-be rival to Starbucks, was kicked off Nasdaq for fabricating transactions; in China its listing probably could have survived. But Zhou Maohua of China Everbright Bank counsels patience, saying the rules will be adjusted over time.

In Gangtai’s case, the company over-stretched itself. The gold-miner and jewellery-maker got pulled into property, even planning a skyscraper, and bought Buccellati, an Italian jeweller. But as it racked up huge losses, it defaulted on bonds and sold its best assets. Delisting is its latest humiliation. At least it can console itself that it will soon have plenty of company. ■

**The world economy****Covid-10trn**

HONG KONG

**Totting up the pandemic’s price tag**

THE ECONOMIC toll of the covid-19 pandemic is incalculable. But let’s try anyway. A useful starting point is the semi-annual *Global Economic Prospects* report released this week by the World Bank. It calculates that the world economy probably shrank by 4.3% in 2020, a setback matched only by the Depression and the two world wars. But this dramatic figure still understates the cost. It measures the world economy’s fall from where it was before the pandemic, not from where it would have been had the virus not spread.

To calculate that bigger fall, economists need an estimate of how global GDP might have evolved in the absence of covid-19. One simple baseline is the World Bank’s projection released this time last year, when it was still blissfully unaware of the lurking viral threat. Back then, it expected global GDP to expand by 2.5% in 2020 to \$86trn. Compared with that figure, the shortfall of global GDP last year was probably more like 6.6%. That is equivalent to

about \$5.6trn (at the market exchange rates and prices prevailing in 2010, which the bank uses for analytical convenience).

In 2021 the world economy should grow unusually briskly, the bank projects, helped by the roll-out of vaccines. But even if this expectation is met and no further calamities intrude, the level of output in 2021 will remain 5.3% below the bank’s pre-pandemic projections: a further shortfall of almost \$4.7trn (see chart).

Put these two numbers together and the cost of covid-19 this year and last will amount to about \$10.3trn in forgone output: goods and services the world could have produced had it remained unafflicted. That is, to put it mildly, a big number. Only America and China have an annual GDP greater than \$10trn. And there are 153 economies that produced less than that between them in 2019. Converted into today’s money, \$10.3trn is enough to buy the ten biggest listed companies in the world, including Amazon, Apple and Saudi Aramco. It is also enough to buy all the property in New York City nine times over.

Over \$2trn of the cost will be suffered by the euro area. America will bear roughly \$1.7trn. Among developing countries, India is set to endure the biggest loss in dollar terms: about \$950bn (although the bank’s forecast for India’s growth in 2021 seems unduly pessimistic). Although China’s economy is much bigger than that of India, it will suffer a smaller GDP shortfall of about \$680bn.

Even these colossal numbers understate the cost, however. The economic damage, after all, will not be confined to this year and last. The World Bank expects global GDP in 2022 to remain 4.4% below its pre-pandemic predictions. It fears lasting harm to investment, human capital and, therefore, the growth potential of the world economy. It also worries that the debt that governments and companies have issued to help them weather the pandemic may harm growth in the future.

There is another reason why these figures understate the economic tab. If the pandemic had never happened, world GDP would not only have been higher, it would also have been different. Instead of masks, tests, vaccines, Zoom calls and parcel deliveries, the world economy would have produced other items. Because the pandemic is so damaging to health and society, it is worth diverting vast resources to fight it—these efforts are of enormous economic value. But if the virus had never spread, these same efforts would have been unnecessary, making them an expense the world could have been spared. ■

**Counting the cost of covid**

GDP forecasts\*, \$trn

**World GDP****GDP shortfall, 2020-21**

Relative to pre-pandemic projections

Sources: World Bank; *The Economist* \*Constant 2010 \$ †Estimate

**Correction:** In last week’s story on infrastructure investment (In the works, January 2nd) we mischaracterised CDPQ’s green-energy portfolio. The Canadian fund is a big shareholder of Invenergy but does not own it entirely. Sorry.



## Free exchange | Social studies

*Could the pandemic cause economists to rethink welfare programmes?*



EVERY JANUARY a curious migration occurs. Thousands of economists from around the world flock to a big American city for the annual meetings of the American Economic Association (AEA). The pandemic upended the rite this year, and instead enabled conference attendees to peer into the living rooms and offices of scholars as they presented their work, much of it focused on the consequences of covid-19, on Zoom. The events of 2020 drew attention to the importance for prosperity of factors that economists often neglect, such as state capacity and social trust. Perhaps in a sign of change to economic thinking to come, some of the fare on offer at this year's shindig suggested that raising welfare is often more a matter of collective choice than maximising efficiency.

Discussions of the role of social norms and values were scattered throughout the conference. Scholars presented work showing that higher levels of trust and social responsibility were associated with less scepticism of media reporting on covid-19 and greater willingness to accept stringent lockdown measures. Other research demonstrated that gender-related aspects of corporate culture are in large part determined by the norms prevailing in local society, but can nonetheless be shaped by national policy. Still other papers examined how economic factors contributed to the unravelling of political norms and the eventual collapse of democracy in Europe before the second world war.

Yet the most pointed discussion of the importance of social forces—and economists' tendency to overlook them—came in a keynote lecture by Emmanuel Saez of the University of California, Berkeley. He is known for his work assembling historical data on income and wealth inequality, but his lecture was far more philosophical than empirical. In it, he asked his fellow economists to rethink their usual approach to the welfare state.

As Mr Saez noted, the standard framework assumes that society is comprised of rational individuals making decisions based on self-interest. Choices about how much to save or what sort of education to acquire are informed by people's understanding of their own conditions and preferences. Economists working under these assumptions may support welfare programmes in the event of market failures. Unemployment benefits are needed, say, because credit markets are far from perfect, and a jobless person cannot

simply borrow to make up for a temporary loss of income, however confident they are of eventually finding work. But the assumption of rational self-interest constrains the welfare state significantly. Generous benefits, and the high taxes needed to fund them, will put rationally minded people off work, undermining economic growth and the government's capacity to help people in need.

In practice, though, Mr Saez explained, the world works differently. Societies have largely chosen to tackle problems such as old-age poverty and inadequate schooling with collective solutions rather than individual ones, through universal pensions and compulsory education. These social choices are partly a response to the difficulties people face providing such things for themselves. But they also reflect values, such as ideas about fairness. The fact that society deems education to be a social good and provides the means to achieve it encourages young people to attend school for years, regardless of whether it is a rational economic choice. And as behavioural economists have shown, people do not exclusively behave as hard-bitten rationalists. The fairness of outcomes matters to people, and they are willing to make sacrifices for the greater good in an environment of social trust and reciprocity.

These observations should influence analyses of public policies. The decision to work, for instance, may be influenced by norms as well as by financial incentives. By considering only the latter, economists might overestimate the work-discouraging effect of welfare schemes. Employment rates for prime-age men are remarkably similar across rich countries, Mr Saez pointed out, despite big differences in tax and welfare systems. Average tax rates in France are roughly 20 percentage points higher than those in America across the income distribution, yet about 80% of middle-aged men work in each country. (Americans do work more hours, but, as Mr Saez noted, this too reflects social choices, such as the shorter working week specified in French law.) There is strong social pressure for healthy men not to be seen as "freeloaders", which pushes against the incentives created by higher taxes or bigger welfare cheques. Where social pressures to work are more ambiguous—as for the young or old or, in many places, women—generous benefits tend to have larger effects on employment decisions, Mr Saez noted. But this reinforces rather than undercuts the idea that social factors have important effects on economic decisions.

### Fair's fair

When social norms guard against "bad" behaviours—those, like voluntary unemployment or tax avoidance, which could be considered to be taking unfair advantage of the system—welfare states present less of a trade-off between efficiency and equity than many economists suspect. Analyses deploying assumptions of hard-nosed self-interest remain useful in such cases, as descriptions of how government schemes could fail if social guardrails are allowed to erode, for example. Yet they are not necessarily the best predictors of what will happen, and the failure to take social preferences seriously could mean that economists' prescriptions for making societies more egalitarian and dynamic fall flat.

Of course, culture changes slowly, both within economics and without. Mr Saez is much further along than most of his peers in emphasising the role of social factors. Yet just as the global financial crisis of 2007-09 prompted a rethink of the profession's understanding of financial markets and macroeconomic policy, the pandemic may focus attention on other blind spots. Next year's conference, when it rolls around, may be a much more social event than this year's—in more ways than one. ■



The future of armed conflict

## Warfare's worldwide web

America's armed forces are designing a new approach to command and control

**A**N OLD PROVERB says you should not put all your eggs in one basket. That is a particularly good maxim for matters military. America's armed forces, for example, use modified Boeing jumbo jets, called JSTARS, as airborne control centres for surveillance and operations. These planes are packed with sensors and their job is to orchestrate combat by detecting targets, tracking them and then assigning them to others to deal with. They have done this well for decades. But times change. With its big electronic signature, a JSTARS aircraft now amounts to "a sluggish flying bull's eye", according to Will Roper, the American air force's head of acquisitions.

Similar doubts are growing about the satellites, warships and other big pieces of hardware involved in the command and control of America's military might. For the past couple of decades the country's generals and admirals have focused their attention on defeating various forms of irregular warfare. For this, these castles in the sky

and at sea have worked well. In the meantime, however, America's rivals have been upgrading their regular forces—including weapons that can destroy such nodes of power. Both China and Russia have successfully blown up orbiting satellites. And both have developed, or are developing, sophisticated long-range anti-aircraft and anti-ship missiles.

As a result, America is trying to devise a different approach to c2, as command and control is known in military jargon. The Department of Defence has dubbed this idea "Joint All-Domain Command and Control", or JADC2. It aims to eliminate vulnerable nodes in the system by multiplying

the number of peer-to-peer data links that connect pieces of military hardware directly to one another, rather than via a control centre that might be eliminated by a single, well-aimed missile.

Nor is that node-reducing ambition confined merely to the sophisticated and expensive stuff. The goal, officials say, is to create a network that links "every sensor and every shooter". When complete, this will encompass sensors as small as soldiers' night-vision gear and sonar buoys drifting at sea, and shooters as potent as ground-based artillery and aerial drones armed with Hellfire missiles.

### Sense and sensibility

One likely beneficiary of the JADC2 approach is Anduril Industries, a Californian firm that makes devices at the sensor end of the sensor-and-shooter list. Its products include small spy helicopter drones; radar, infrared and optical systems constructed as solar-powered towers; and paperback-sized ground sensors that can be disguised as rocks. In tests, the American air force has networked these products with fighter jets, ground-based artillery, surface-to-air missiles and "hunter-killer" drones. As Christian Brose, once staff director of the Senate Armed Services Committee and now Anduril's chief strategy officer, observes, the variety of kit involved in this sort of approach permits equipment that is

---

→ Also in this section

---

69 How dogs were domesticated

---

69 Oceanic cartography

---

70 Herbal medicine's uses

---





**This is not a game**

▶ failing to do a useful job in a particular set of circumstances to be “swapped out” and replaced by something else.

Sensors come in still-more-diverse forms than Anduril’s, though. An autonomous doglike robot (pictured on previous page) made by Ghost Robotics of Philadelphia offers a hint of things to come. In addition to infrared and video systems, this quadruped, dubbed v6o Q-UGV, can be equipped with acoustic sensors (to recognise, among other things, animal and human footsteps), a millimetre-wave scanner (to see through walls) and “sniffers” that identify radiation, chemicals and electromagnetic signals. Thanks to navigation systems developed for self-driving cars, v6o Q-UGV can scamper across rough terrain, climb stairs and hide from people. In a test by the air force this robot was able to spot a mobile missile launcher and pass its location on directly to an artillery team.

### Only connect

Artificial intelligence (AI) is an important ingredient of all this. Among other things, AI can work out the combination of hardware best suited to take on threats “popping up in the battlespace”, says Todd Harrison, a defence analyst at the Centre for Strategic and International Studies, an American think-tank. He likens this to the function of apps that match ride-hailers with the most appropriate drivers. The more decentralised the AI processing is, the better. Pushing it “out to the tactical edge”, as JADC2 geeks are wont to put it, reduces the amount of data to be transmitted, and thus the amount available for an enemy to intercept or jam.

Applying AI to more C2 processes will also increase the celerity with which strikes can be ordered. Existing procedures often require raw sensor data to be sent to an operations centre, where they are

stitched together and studied by staff before commanders order strikes. This can take tens of minutes, during which a target may slip away or fight back, says Jeff Kline, a retired naval officer who is now a researcher at the Naval Postgraduate School in Monterey, California. AI should cut that delay. In a demonstration in September, army artillery controlled by AI and fed instructions by air-force sensors shot down a cruise missile in a response that Dr Roper describes as “blistering”.

A JADC2 rich in AI promises not just faster decisions, but better ones. It could, for example, assign planes to bombing missions that require aerial refuelling to complete. By taking into account things like wind speeds, air defences, flight altitudes and the weights and stealth of the planes concerned, AI can find efficiencies that might elude rushed human dispatchers.

Perhaps most valuably, JADC2 will devise courses of action that commanders might not otherwise have realised were possible. AI can, for example, keep track of a government’s myriad cyber capabilities and propose actions that might be relevant for an operation. It might inform a commander that a building to be destroyed could be first emptied thanks to an ability to activate its fire alarm or sprinklers. Or it might determine that temporarily disabling an area’s electricity or telecommunications network would render a strike unnecessary. It can also sort through probable knock-on effects of an action, to warn, say, that a certain type of blast might contaminate a local water supply.

JADC2’s supporters envisage a wide-ranging system. By sifting through satellite imagery, AI could flag a troubling change in activity in a port, says Mr Kline. Postings on social media could alert AI to unusual troop movements abroad. And JADC2 will no doubt also ingest reports written by hu-

man spies, says David Deptula, dean of the Mitchell Institute for Aerospace Studies, an American think-tank.

There are, however, numerous obstacles to the success of all this. For a start, developing unhackable software for the purpose will be hard. Legions of machines containing proprietary and classified technologies, new and old, will have to be connected seamlessly, often without adding antennae or other equipment that would spoil their stealthiness.

There are human obstacles, too. For one thing, JADC2 is intended to link systems belonging to the air force, army, marines, navy, space force and intelligence agencies. Battles over which of these will be crowned the master setter of technical standards have duly begun.

The army, which calls its part of JADC2 Project Convergence, is unlikely to carry the day. It has less experience than the other services in managing long-range data networks and is generally considered too low-tech to pull things off.

A stronger case is made by the navy, which has dubbed its slice of JADC2 Project Overmatch. The navy already operates impressive networks involving submarines, surface vessels, aircraft and satellites. However, its reputation of having a culture of operational independence may count against it.

The likeliest leader, therefore, is the air force. This service is able to operate over the entire planet. It is also already in possession of Battlefield Airborne Communications Node (BACN), a system that translates and relays data between dissimilar communications arrangements without requiring either their prior modification or that they be within line of sight of each other. BACN’s operational success, Mr Deptula says, suggests that it or similar data translators could help build an ethereal nervous system for JADC2.

### Net benefits

Big bucks will be needed, too. Members of America’s Congress tend to like military hardware, which brings the promise of “politically engineered” manufacturing in their constituencies. Intangibles such as data protocols are a more difficult sell. And it probably will not help that some vocal voters fear a weapons network with AI might one day take over for itself the decision of what to attack, in the fashion of Sky-net in the “Terminator” films. Officials stress that such autonomy is not on the cards. Beyond that, last year the defence department adopted an AI-ethics charter which requires, among other things, that humans remain in control of, and responsible for, AI systems. The question is whether those limits will continue to hold if America’s adversaries one day secure an edge by giving their own AI freer rein. ▶



▶ America's allies may pose problems of a different sort. Some other countries, especially in Europe, have restrictions on how their armed forces' kit may be used in multinational operations. Programming JADC2 to respect this patchwork of caveats will not be easy, says Henrik Breitenbauch, head of Copenhagen University's Centre for Military Studies. Beyond that, some allies' data networks contain Chinese components, which many suspect harbour secret back doors for espionage or sabotage.

Efforts by America's principal rivals to develop their own weapons-networking software are also thickening the plot. It is by no means clear that America will come out on top in this arms race. China's AI developers are able to train algorithms using unparalleled pools of data, garnered thanks to the country's weak privacy protections and huge population. China and Russia are also investing heavily in dis-

rupting C2, Mr Harrison notes.

In exercises in the Arctic, and in fighting in Ukraine and Syria, Russian forces have intercepted and disrupted terrestrial and satellite signals, worked out the locations of the hardware involved, and relayed the co-ordinates to targeting systems. The sophistication involved has persuaded the American army to halt a chunk of development work for a new communications network called WIN-T. This will need, Mr Harrison says, to become "much more robust, hardened, protected" than planned.

America's technologists must, then, link the country's military equipment into a "kill web" so robust that attempts to cripple it will amount to "trying to pop a balloon with one finger", as Timothy Grayson, head of strategic technologies at DARPA, the defence department's main research agency, puts it. Yet they must also keep that network under ultimate human control. ■

### The origin of dogs

## Woof! Woof!

### A new idea about how dogs were domesticated

**M**AN'S BEST friend is also his oldest. The partnership between dogs and people may go back as much as 40,000 years—long predating any other domestication. And it is based not, as is the case with many subsequent domestications, on a human desire to eat the animal concerned, or to consume some associated product such as milk or eggs, but rather on genuine companionship, albeit with a little work- and hunting-related exploitation on the side.

How this partnership got going, though, is debated. In particular, unlike other domestications, which involved groups of people who had taken up farming, the domestication of the wolves that became dogs happened while all human beings were still hunter-gatherers. The two species were, in other words, competitors. Yet they managed to become soul mates.

One popular theory is that the wolves which became dogs acted as rubbish-disposal agents for groups of people, by eating their waste, possibly including their faeces. That, though, would be a service more useful to settled farmers than mobile hunter-gatherers. As she writes in *Scientific Reports*, however, Maria Lahtinen of the Finnish Museum of Natural History thinks she might have the answer as to how wolves and people squared the competitive circle while both species were still hunters. It was, she and her colleagues suggest, simply a matter of surplus calories.

The archaeological evidence suggests that wolves were domesticated in woodlands fringing the ice sheets of the last ice age, since that is where almost all Palaeolithic dog remains have been found. Dr Lahtinen calculates that, given the large size of prey animals in this environment, and humans' need to eat a balanced diet with plenty of plant matter in it as well as flesh, there would have been a lot of surplus meat around from kills. What better way to use some of it than to feed a few wolf cubs to provide entertainment and companionship? And thus, she suggests, were dogs born.



An ex-best friend

### Oceanic cartography

## Full fathom five

### How to map the seabed from the sky

**A**N ALIEN SEEKING a name for the third planet from the sun might reasonably plump for "Sea" or "Ocean", rather than "Earth". Two-thirds of its surface is covered by salt water, and its predominant colour, viewed from far away in space, is blue. What underlies all this brine, though, remains surprisingly mysterious to the planet's ape-descended inhabitants. As recently as 2019, for example, researchers found several thousand new underwater mountains, known as seamounts, by measuring the effects of their gravity on the ocean's surface. More such discoveries almost certainly await.

One important reason for ignorance about the seabed is the lack of a tool that can easily map its topography from an aircraft flying above the water. That, though, is about to change. Researchers at Stanford University, led by Amin Arbabian, an electrical engineer, have developed what they call the Photoacoustic Airborne Sonar System, PASS. This makes it possible to scan the ocean floor rapidly, from a helicopter, rather than relying on a slow-moving ship or submarine.

The problem to be solved is that sound waves, in the form of sonar, are the only reasonable way to accomplish such mapping. Both light beams and the radio waves of radar are rapidly absorbed by water. Sound, by contrast, propagates well. What it does not do well is cross the boundary between water and air. When this happens its amplitude is diminished a millionfold. That diminution applies in both directions, so a pulse of sonar broadcast from an aircraft and reflected back to it from the sea floor would have a trillionth of its original amplitude. Expecting to detect such a reflection would be a fool's errand.

PASS partly overcomes the air-sea boundary problem by circumventing the first of those crossings. It does so by generating the sonar pulses not on board the aircraft but rather in the water itself, using intense bursts of laser light fired at the water's surface. These heat the water, causing rapid expansion. That generates a sound wave which propagates to the sea floor, whence it is reflected back to the surface. Only then does it cross the energy-sapping interface between water and air. Though that still weakens the signal a lot, the other part of PASS, a device called a CMUT, is sensitive enough to detect it.

CMUT stands for capacitive microma- ▶▶



▶ chined ultrasonic transducer. As its name suggests, it is a species of electrical capacitor, and, like all such, it is composed of two parallel plates. Any disturbance of these plates, such as the vibration induced by a sound wave, changes the capacitor's properties in a way that is easily detected.

CMUTS were developed at Stanford two decades ago. They are widely used in ultrasonic medical scanners and are made in the same way as the micro-electromechanical deceleration sensors which trigger the deployment of car air bags, so they can be mass produced. PASS employs CMUTS tuned to resonate at the exact frequency of the sonic pulse generated by the laser. This has the double benefit of improving reception and filtering out background noise.

Preliminary tests in a university fish tank used a laser weighing 50kg, but this was a general-purpose device and the apparatus could, the team reckon, be scaled down to weigh just a few kilograms. That would fit on commercial camera-carrying drones. A device this size would be able to "see" through tens of metres of water, making it suitable for use above rivers, lakes and coastal waters. A larger version for deep-sea operations would fit on a manned helicopter or a larger drone and would be able to peer down to depths of hundreds, and eventually thousands, of metres. The team's researchers imagine fleets of such drones making short work of the task of charting the abyss.

### Deep thoughts

Besides the scientific value of mapping the seabed with the sort of resolution normal for terrestrial cartography, PASS will also be able to locate the wrecks of missing ships and aircraft, and engage in commercial tasks such as monitoring underwater infrastructure like oil and gas pipelines.

There are military applications, too, particularly for the detection of submarines. In this context it is no surprise that the project is being sponsored by America's Office of Naval Research. But for inhabitants of the third rock from the sun—or, at least, for those of them interested in hidden aspects of the orb they inhabit—the generation of the first high-resolution map of all of that orb's solid surface will be a matter of moment in its own right. ■

### The Richard Casement internship

We invite applications for the 2021 Richard Casement internship. We are looking for a would-be journalist to spend three months of the summer working on the newspaper in London (covid-19 permitting; otherwise remotely), writing about science and technology. Applicants should compose a letter introducing themselves and an article of about 600 words that they think would be suitable for publication in the Science & Technology section. The successful candidate will receive a stipend of £2,000 a month. Applications must reach us by midnight on January 29th. They should be sent to: [casement2021@economist.com](mailto:casement2021@economist.com)

### Traditional medicine

## Treating forgotten killers

### Herbal remedies can help ameliorate neglected diseases

“WHAT DO YOU call traditional medicine that works?” “Medicine.” This old joke contains more than a milligram of truth. When, for example, Tu Youyou, a Chinese chemist, began testing the sweet wormwood used in local herbal remedies as a cure for malaria, her isolation of artemisinin saved millions of lives and earned her the Nobel prize for medicine in 2015.

But not every folk cure is so closely examined—nor is every condition. Over 1.7bn people, most living in the world's poorest countries, are affected by a group of 20 illnesses known as Neglected Tropical Diseases (NTDs). These often lead to disability and place a heavy burden on health-care systems badly equipped to deal with them.

They are referred to as “neglected” for a reason. A study published in 2009, in *International Health*, estimated that they received only 0.6% of the money given by rich countries to poor ones for health purposes. Things have not improved since then. A recent report by Policy Cures Research, an international think-tank, estimates the cash available for treating NTDs has been flat for a decade, with less allocated to all of them collectively than either malaria or tuberculosis receives alone.

This lack of resources has consequences. In Ghana, though estimated rates of lymphatic filariasis (also known as elephantiasis) dropped by 88% between 2010 and 2018, those of schistosomiasis (also known as bilharzia) and onchocerciasis (also known as river blindness) rose by 39% and 81% respectively. However, Dorcas

Osei-Safo of the University of Ghana has a plan to fight back. Herbal medicine is important in the country. Indeed, its Food and Drugs Authority has already approved several herbal remedies for use against diseases including malaria. She intends to build on this approach.

To do so, she and her team first contacted several practitioners of traditional medicine and obtained samples of 15 treatments employed against a range of NTDs. Some were mixtures of dried herbs, others watery concoctions. Her goal was to test their effectiveness against laboratory cultures of a variety of disease-causing parasites, with the aim of isolating any active principles they might contain.

Nearly all the samples had some effect against one or more parasites. But one stood out in particular when used against the trypanosomes that cause sleeping sickness. This was a dried mix of *Aloe vera*, a short-stemmed succulent, and *Taraxacum officinale*, the common dandelion. Intrigued by that discovery, the team put the crude sample they were working on through two rounds of chromatography, to split it into its constituents, and repeated the tests on these. Their analysis, just published in *PLOS Neglected Tropical Diseases*, revealed an oil which proved 30% more effective at killing trypanosome parasites than did diminazene aceturate, the standard anti-trypanosomal drug.

For many researchers, that would have been the cue for a trip to the patent office and negotiations with a drug company about further rounds of testing. But for Dr Osei-Safo the point is not to make a refined pharmaceutical, but rather to direct those who are ill towards the best treatments available from herbalists. Her next move, funding permitting, will be to try to understand better why the newly discovered oil is effective, and to establish in what circumstances the herbal remedy from which it is derived should be recommended. ■



Herbs of health





### Authenticating art

## Computer says no

**New techniques that make it easier to authenticate paintings—and spot forgeries—are shaking up the art world**

FOR ART historians trying to tell the fake from the real, the Russian avant-garde presents unique challenges. As Soviet rule took hold, adventurous works were spirited abroad and snapped up by collectors. Amid the chaos, forgers abounded. Tracing the early history of a Russian modernist painting—a traditionally genteel business known as provenance study—is tricky. But laboratory tests can help.

In a show scheduled to run until February, the Museum Ludwig in Cologne makes a virtue of that predicament. After a hard scientific look at part of its Russian avant-garde collection, it found that 22 of the 49 works it studied were wrongly attributed. ArtDiscovery—a consultancy that offers private laboratory services for paintings—affirmed the authenticity of 14 exhibits. The show presents the downgraded works alongside genuine ones and explains the methods used, from electron microscopy to new x-ray techniques. The public can peruse the scientific reports along with conventional art-historical essays. The Ludwig's conservators see their investigations

as part of an ongoing pursuit of the enigmatic story of Russian modernism.

Canvases rescued from Stalin present specific problems, but tracing the path of a 17th-century Old Master (which aristocrat commissioned it, how often it changed hands) can be just as fraught, says Friederike von Brühl, a Berlin-based art lawyer. If great collections were to turn the full light of science on their venerable oil paintings, she reckons, “they will find many wrong attributions”. Yet the spirit of openness—to technology, debate and the public—on show in Cologne is by no means universal. Old-fashioned connoisseurs can be snobbish and defensive about laser-wielding scientists, unsurprisingly, given what is at stake: not just the judgments of scholars, but potentially the reputations and holdings of galleries and collectors. For all the obstinacy, though, the march of science into art is proving irresistible.

Conventional scholarship involves the study of aesthetics, style and historical records. The oeuvre of a great painter has traditionally been defined by a scholarly pan-

### → Also in this section

72 The Cultural Revolution

73 Arctic explorers

74 Revisiting the Troubles

74 A twisty novel of trauma

el that maintains a definitive catalogue of the artist's authentic works. The Corpus Rubenianum, for instance, is an Antwerp-based body that adjudicates the work of Peter Paul Rubens; it reveres the legacy of Ludwig Burchard, a German-born expert who died in 1960. Yet such scholarly deference can be excessive: many of Burchard's attributions have turned out to be mistaken, as the Rubenianum has quietly acknowledged. “There is no question that more scientific examination is needed” to clean up the Flemish master's oeuvre, says Kasia Pisarek, a Polish-born British art scholar, whose doctoral thesis traces what she calls a crisis of connoisseurship.

### Watching the watchmen

The increasing sharpness and availability of scientific tools, including photography at ultra-high resolution, offer curators a fresh, overdue chance to clarify their holdings, Ms Pisarek says: “They now have an opportunity which they take too rarely.” New methods make it easier than ever to dissect the pigments, brushwork, canvas and physical structure of a painting, sometimes without taking it off the wall.

In his native Germany, Matthias Alfeld, now of Delft University, operated a synchrotron, a building-sized machine that subjects artefacts or tiny samples to super-powerful beams. Now he teaches Dutch students to use a hand-held tube that analyses objects non-intrusively with x-ray fluorescence, laying bare the composition ▶



▶ of paintings and frames—not as powerful as the synchrotron, but easier and cheaper.

Another tool is multispectral imaging, which exposes a painting's many layers. A clever forger can mimic the elements in ancient pigments, but a peep at a reused canvas can expose fraud. Conversely, shadowy, underlying marks known as pentimenti are a sign of authenticity. Charles Falco, an emeritus professor at the University of Arizona, has developed easily portable infrared cameras and spectrometers—though so far, he says gloomily, they are more likely to be used on remote archaeological sites than on national art treasures.

Information gleaned from all these tools can be fused to create many gigabytes of data. And an up-and-coming method uses a neural network, a form of artificial intelligence (AI) that mimics the structure of the human brain, to identify common features in a painter's known works, especially brushstrokes; this information is then employed to scrutinise an uncertain offering. Christiane Hoppe-Oehl, a co-founder of Art Recognition—a Zurich start-up that compares images of a contested piece with hundreds of thousands in a database—thinks AI can become a “fourth pillar” of art research along with style analysis, provenance study and laboratory work.

In addition to the museum in Cologne, some countries and enthusiasts have embraced these insurgent techniques. Authentication in Art, a movement based in The Hague, has set up an arbitration court that aims to enlist both science and old-fashioned art history to adjudicate puzzling works. The Rembrandt Research Project, a bid to define the oeuvre of the Netherlands' greatest painter, enjoys global respect. The Rijksmuseum in Amsterdam invited the public to follow centimetre by centimetre a revealing spectroscopic examination of Rembrandt's “The Night Watch” (pictured on previous page).

### Old masters, new tricks

A thorough study of Old Masters, predicts Ms Pisarek, the art scholar, might produce pleasant surprises as well as shocks: paintings now dismissed as copies and lying in museum storage rooms could be upgraded to originals. On the other hand, she too thinks some public collections are still tainted by faulty attributions made in the early 20th century, when Americans snapped up supposed masterpieces from opportunistic sellers. But vested interests and inertia have thus far made the Dutch spirit of *glasnost* an exception.

Perhaps not for long. The commercial art market is well aware that it cannot ignore science. Sotheby's, the London-based auction house, bought an American laboratory in 2016; its rival Christie's uses lots of private scientific services. Meanwhile, although many state-owned museums re-

main cautious, other organs of state, from judges to police, are accepting the value of science in adjudicating disputes over art.

In a recent case concerning a copy of an Impressionist painting, a European customs authority asked the owner for a document proving it was not original. The relevant scholarly committee could not help, but a certificate from Art Recognition sufficed. In another case, a German regional government possessed a painting it believed to be fake and wanted legally satisfying proof. Laboratory work by ArtDiscovery supplied the necessary evidence.

### The Cultural Revolution

## Changing the guards

A Chinese writer's revealing account of a formative period in his country's history

AS MOST PEOPLE understand it, the Cultural Revolution of 1966-76 was a period of unmitigated horror, a time when frenzied mobs unleashed by Mao Zedong ran amok across China, killing and torturing, ransacking homes, destroying religious sites and erasing much of the tangible heritage of one of the world's great civilisations. Yet it was far more complex than that.

The gangs of Red Guards involved in the violence were not part of a national organisation. There were a myriad of them, their members exploiting a rare moment in the history of Communist rule in China when people were allowed to organise themselves spontaneously. That is why, when pondering alternatives to autocracy, the Cultural Revolution weighs so heavily on the minds of some Chinese. Were the party



To rebel was justified

Jilleen Nadolny, who runs ArtDiscovery's British arm, sees no risk that human expertise will become otiose; users of her equipment draw on general art history, she says, just as radiographers rely on medicine. Pigment analysis, a great tool for dating pictures, requires fine visual judgment. The precious mineral-based colours preferred by Rubens show up under an electron microscope, but telling a natural ultramarine from a modern synthetic one still requires a sensitive eye. Learned aesthetes have not lost their authority. But, increasingly, they have to share it. ■

### The World Turned Upside Down.

By Yang Jisheng. Translated by Stacy Mosher and Guo Jian. *Farrar, Straus and Giroux*; 768 pages; \$40

to loosen its grip, would China be engulfed in mayhem again, only this time without a Mao to reimpose order?

There has been no shortage of literature describing the suffering caused by the Cultural Revolution and the deep, still-painful wounds it inflicted. Writers inside China, however, have been restrained by the party from exploring the politics of that period. The party admits that the Cultural Revolution was a disaster, but it wants to preserve Mao's image as Communist China's hallowed founding father. It blames the disorder largely on the chairman's wife, Jiang Qing, and other members of the “Gang of Four”. It does not want people to look too closely at the differences between Red Guard groups, nor at why former members of some of them have thrived in the post-Mao era.

Such taboos make Yang Jisheng's “The World Turned Upside Down” a rarity. The author is a retired journalist from the state news agency, Xinhua—a position that made him privy to the party's inner workings. But he is no stooge. His earlier book, “Tombstone”, which described the famine caused by Mao's Great Leap Forward of the late 1950s, was one of the most shocking accounts by an author in China of that calamity. Like “Tombstone”, his latest work is banned in mainland China, though a Chinese-language edition was published in Hong Kong in 2016. This new English translation is an abridged version.

For the non-specialist, “The World Turned Upside Down” is a challenging read. It makes few concessions to those un- ▶



▶ familiar with the language and politics of the time. People are sometimes introduced without reference to the post-Mao roles for which they are now known—and the end-notes do not always help. The style is clunky and the narrative disjointed. Long lists of attendees at meetings and other such encumbrances often give the book the feel of an official chronicle.

Yet Mr Yang's argument is clear and important. It is that many of the Red Guards were victims themselves, and that what motivated some of them was not a love of tyranny, but quite the opposite: the chance to wreak revenge on Communist bureaucrats who had been oppressing them. Mr Yang describes the Cultural Revolution as a "triangular game". It involved Mao, the bureaucrats (and the "conservative" Red Guards they supported), and "rebel" Red Guards whom Mao tried to use to topple the bureaucrats blocking his Utopian—and destructive—plans for China's social and economic transformation. The winners were the bureaucrats and the Red Guards aligned with them. They were the pragmatists who went on to rule China.

During the decade of the Cultural Revolution, the rebel faction was in the ascendancy for only about two years. When it had the upper hand, it was "savage and cruel", says Mr Yang. But the savagery of the conservative Red Guards and their backers was worse. Far more rebels were killed or persecuted than Red Guards from the other side. After Deng Xiaoping became China's de facto leader in 1978, he focused his sweeping purge of Cultural Revolution activists on them, not on the conservatives.

Sadly—though sensibly for a writer who lives in China—Mr Yang does not examine the Red Guard backgrounds of current leaders. Xi Jinping, now president and party chief, was unable to join up because Mao had purged his father, a senior official. As a teenager Mr Xi was detained by rebel Red Guards and forced to denounce his father. Now he encourages reverence of Mao as a way of strengthening the party's legitimacy. But he is not heard repeating Mao's belief that Marxism could be summed up in a sentence: "To rebel is justified." In Mr Yang's telling, even Mao himself found that the genie of rebellion, once released, was "more than he himself could subdue", and that corking it up again required the help of those he had wanted out of his way.

For Mao's successors, including Mr Xi, ruling China has been about maintaining the status quo. But in the long run, the party's obsession with order may not work, either. Mr Yang predicts that eventually its "oppressive tactics" will cause an "unprecedented social explosion". He does not speculate on whether this might prove as bloody as the Cultural Revolution, when millions were killed or persecuted. But even today, that fear endures. ■



Arctic explorers

## Northern exposure

**Icebound.** By Andrea Pitzer. Scribner; 320 pages; \$29. Simon & Schuster; £20

WHEN WILLIAM BARENTS, a Dutch navigator, sailed to the Arctic in 1594, he was pursuing the dream of a warm northern ocean first posited by the Greeks. The idea of a polar trade route to the Orient—above North America or the Russian Far East—enticed European explorers for centuries. Yet it proved a "lethal delusion", and Barents's missions a template for many harrowing trials.

Beyond the sea north of Scandinavia that bears his name, Barents and his tale are little known. Considered "the first true polar voyage", his quest was eclipsed by the 19th-century exploits of Robert Peary and the ill-fated expedition led by John Franklin. Andrea Pitzer, an American journalist, recently sailed the same seas to Nova Zembla to recount this earlier, nail-biting feat of seafaring.

Backed by Dutch merchants keen to make their fledgling state a maritime power, Barents made three journeys north in the 1590s. Ms Pitzer relies not just on a 19th-century translation of the journals of Gerrit de Veer, who accompanied the voyages, but on a previously untranslated account by a merchant representative. The polar ice was insurmountable on the first two expeditions; they were largely uneventful and barely stir a reader's blood. But once Barents heads for the northern tip of Nova Zembla for the third time in May 1596, the story becomes dramatic, and dire.

He and his crew break away from a companion ship to forge on alone, determined to be first to find the elusive pas-

sage. For weeks the 17 men fight off polar bears that rear up from nowhere, attacking until they are slaughtered or driven away. The ship tacks endlessly and desperately to escape floating "mountains of steel": icebergs so impenetrable that the only way through is to drill holes and pray they will split apart. By mid-September the vessel is frozen fast, and the men resign themselves to overwintering "in great cold, poverty, misery and griefe". Poorly clad and ravaged by scurvy, they are "phenomenally unprepared" for the ordeal, Ms Pitzer observes. Yet the remains of the shelter they managed to build stood for nearly 300 years.

Of the men themselves, 13 live through this long polar night—eight months of what the author neatly terms "the monotony of survival". They dig out from continual blizzards, scavenging for fuel and Arctic foxes whose meat contains just enough vitamin C to sustain them. Still, the journey is filled with wonders: optical phenomena and mysteries unravelled, such as where European songbirds go each summer. Ms Pitzer's descriptions of the region sing. "Bits of floating ice released tiny bubbles of air, hissing like oil in a skillet," she writes. "The many languages of water surrounded them day and night."

Barents's heroism helped make the Arctic explorer a mythically resilient figure. The fantasy that drove him, meanwhile, has nearly come to pass. Arctic ice has been shrinking for several decades, with a sharp drop-off after 2006. Human ingenuity, epitomised by expeditions like his, has in 400 years made the Dutchman's dream a terrifying reality.



## The Troubles

## Close quarters

**Anatomy of a Killing.** By Ian Cobain. *Granta*; 304 pages; £18.99

HARRY MURRAY and Millar McAllister had much in common. They were born in the 1940s to humble families in Protestant Northern Ireland, a world where the main employers included the security forces and declining textile factories. Yet one morning in April 1978 Mr Murray entered McAllister's garden in Lisburn, south of Belfast, and shot him dead in front of his seven-year-old son. The boy was dumbstruck, then screamed. Four decades on, the killer regrets distressing the child but still feels the mission was legitimate.

As Ian Cobain, a veteran investigative journalist, shows in his formidably researched book, this killing happened in a context. Or rather, it occurred within a deadly series of concentric rings which seemed to trap those in the middle.

McAllister was a well-liked character with two passions, cameras and pigeons. He worked as a police photographer, writing a column on his beloved birds as a hobby. Mr Murray was an unusual case of a Protestant who joined the Irish Republican Army (IRA). After marrying a Catholic, he had faced intimidation from his own community and ricocheted to the other side. The pigeon-fancying notes helped the IRA track McAllister down; Mr Murray was given an order to kill—and duly carried it out.

The broader context, as Mr Cobain carefully shows, was the escalating contest of wits and will between the IRA and the Brit-

ish authorities, in which each side's violent fury exacerbated the other's. Brutal forms of interrogation and incarceration redoubled the Republicans' determination to fight a long war. A British drive to increase the role of local recruits as police and part-time soldiers made it inevitable that more would be killed (while reducing the toll among English troops). That in turn made the struggle more personal. Prison officers, mainly Protestant, vented their rage on captives who might have killed their friends—and might yet target them.

Mr Murray and his suspected accomplices were quickly arrested; most received long sentences. One was found hanged in his cell. Phelim Hamill, these days a university lecturer, faced charges that were later dropped. Speaking to Mr Cobain, Feilim O Hadhmaill (the Irish form of his name he now prefers) vividly recalls waterboarding sessions. These are described without bitterness: he insists his main concern now is with peace, reconciliation and the truth.

But how can truth and reconciliation be pursued while the claims of justice are honoured, too? The conflict had largely ended even before the peace agreement of 1998; as it recedes, dealing with the past has become the hardest knot for Northern Ireland's well-wishers to untie. Many Protestants dream of putting IRA killers on trial, and occasionally succeed. Some Irish nationalists insist on holding to account those who did wrong in the service of the crown. Words like "justice" and "truth" have become weapons; neither has much to do with reconciliation.

Like Patrick Radden Keefe, an American author who anatomised the "execution" by Republicans of a hapless mother of ten, Mr Cobain is engaged in an alternative form of truth discovery. He forensically exposes the tangle of motives that prompted ordinary people, neither stupid nor psychopathic, to do unspeakable things. ■

## British fiction

## Memory lane

**Asylum Road.** By Olivia Sudjic. *Bloomsbury*; 272 pages; £14.99

WHEN OLIVIA SUDJIC'S debut novel, "Sympathy", a study of a young woman's obsession with social media, was published in 2017 it was hailed as "the first great Instagram novel"; she followed it with "Exposure", an extended essay about the internet, impostor syndrome and the withering self-consciousness of twenty-somethings. Aspects of both works creep into Ms Sudjic's haunting and haunted second novel, "Asylum Road", but its scope is broader and its artistic grip more certain.

Anya, the narrator for most of the story, is working desultorily on a PhD thesis in art history. At first her world seems prosaically upper-middle class: she lives in London with her boyfriend, Luke, a bioscientist, in a flat bought by his parents, and is about to go on holiday in the south of France. Yet already something is askew. The couple share a fascination with true-crime podcasts, and the book opens with a startling sentence that will resonate: "Sometimes it felt like the murders kept us together."

Amid a vague mood of menace and coercion, the pair become engaged. Anya, though, is a bag of nerves masquerading as a functioning adult. She fakes emotions, picks at her face and is disgusted by her body. Her breasts, for example, are alternately described as "white meat" and "two live creatures". In fragmented psychological prose, Ms Sudjic stealthily plants clues to her ultimate subject—the trauma inflicted by Anya's childhood in Sarajevo, the dislocations of the Bosnian war, severance from her parents and a relative's suicide.

When, disastrously, the couple travel to Sarajevo together, deep, unhealed scars begin to open. The mind of Anya's mother is stuck in a city under siege. Half-submerged memories resurface in sharp, violent imagery: in a hotel room, "a line of moth holes in the heavy curtain shone white-hot like bullet holes". The characters narrowly escape death on a lethally winding road.

The author switches briefly to third-person narration as both plot and protagonist unravel. Anya revisits other parts of her past: her university years; a cousin who once forced her to take part in a deer hunt, a scene infused, like others, with echoes of previous bloodshed. As Anya moves to the *Asylum Road* of the title, Ms Sudjic coolly executes a climax as treacherous and unexpected as a hairpin bend. ■



On the home front





# A New Challenge?

**Unique Access to Confidential Opportunities**

InterExec is the global leader in enabling Top Executives to access \$200k to \$2m+ unadvertised vacancies worldwide. We act discreetly through a 15,000 strong international network.

**InterExec**  
UNIQUE NETWORK • OUTSTANDING TALENT

london@interexec.net www.interexec.net +44 (0)20 7256 5085



**HARVARD Kennedy School**  
**MOSSAVAR-RAHMANI CENTER**  
for Business and Government

The Mossavar-Rahmani Center for Business and Government at Harvard Kennedy School invites distinguished professionals with at least 20 years of experience in government and/or business to apply for a one-year, unpaid appointment as Senior Fellow to conduct research on topics at the intersection of the public and private sectors, including regulation, corporate governance, and the role of government in the changing global economy. The Center is led by Lawrence Summers, University Professor, and has numerous Harvard faculty as members.

*Deadline for applications is **March 1, 2021.***

*For more information please visit*

[www.hks.harvard.edu/centers/mrcbg/about/program-description](http://www.hks.harvard.edu/centers/mrcbg/about/program-description)

**Readers are recommended** to make appropriate enquiries and take appropriate advice before sending money, incurring any expense or entering into a binding commitment in relation to an advertisement.

The Economist Newspaper Limited shall not be liable to any person for loss or damage incurred or suffered as a result of his/her accepting or offering to accept an invitation contained in any advertisement published in *The Economist*.

**Tenders**



REPUBLIKA E SHQIPËRISË

**MINISTRY OF INFRASTRUCTURE AND ENERGY**

**NOTIFICATION OF THE CONTRACT**

- Name and Address of Contracting Authority:** Ministry of Infrastructure and Energy, Str. "Abdi Toptani", No. 1, Tirane.
- Name and address of the person responsible:** Teuta Balili, Ministry of Infrastructure and Energy, (e-mail: [teuta.balili@infrastruktura.gov.al](mailto:teuta.balili@infrastruktura.gov.al); cc: [ervin.duraj@infrastruktura.gov.al](mailto:ervin.duraj@infrastruktura.gov.al)).
- Type of contracting authority:** Central Institution.
- The form, object and type of contract:** *The form:* Concession/PPP; *The object:* Design, Build, Operate, Maintenance and Transfer of a tourist port in the city of Vlora (Marina Vlora), *Type of contract* is "Work".
- Contract duration:** 35 years.
- The location of the contract:** Vlora Marina is planned to be built in the city of Vlora and specifically in the current port of this city.
- Legal, economic, financial and technical information and Criteria for the selection of the winner:** In accordance with Appendix 9 and 11 of DPK.
- Deadline for submission of bids:** Within and not later than: Date 26th of February 2021, 14:00 (CET).
- Deadline for opening of bids:** Within and not later than: Date 26th of February 2021, 14:00 (CET).
- Period of validity of bids:** 150 days.

HEAD OF CONTRACTING AUTHORITY  
**BELINDA BALLUKU**



## Economic data

	Gross domestic product			Consumer prices		Unemployment rate		Current-account balance		Budget balance		Interest rates		Currency units	
	% change on year ago latest	quarter*	2020†	% change on year ago latest	2020†	%		% of GDP, 2020†	% of GDP, 2020†	10-yr gov't bonds latest,%	change on year ago, bp	per \$ Jan 6th	% change on year ago		
United States	-2.8	Q3	33.4	-3.7	1.2	Nov	1.2	6.7	Nov	-2.3	-14.9	1.0	-77.0	-	
China	4.9	Q3	11.2	1.9	-0.5	Nov	2.4	4.2	Q3 <sup>§</sup>	1.3	-5.2	2.9	6.0	6.46	7.9
Japan	-5.7	Q3	22.9	-5.3	-1.0	Nov	0.1	2.9	Nov	2.6	-11.3	nil	-8.0	103	4.8
Britain	-8.6	Q3	81.1	-11.3	0.3	Nov	1.0	4.9	Sep <sup>††</sup>	-1.5	-19.6	0.3	-55.0	0.74	2.7
Canada	-5.2	Q3	40.5	-5.8	1.0	Nov	0.7	8.5	Nov	-1.7	-13.5	0.8	-83.0	1.27	2.4
Euro area	-4.3	Q3	60.0	-7.5	-0.3	Nov	0.3	8.4	Oct	2.6	-9.1	-0.6	-27.0	0.81	9.9
Austria	-4.0	Q3	54.6	-6.4	1.3	Nov	1.1	5.4	Oct	1.2	-7.8	-0.4	-32.0	0.81	9.9
Belgium	-4.5	Q3	54.2	-7.9	0.4	Dec	0.4	5.1	Oct	-1.3	-9.1	-0.3	-36.0	0.81	9.9
France	-3.9	Q3	98.3	-9.2	nil	Dec	0.5	8.6	Oct	-2.3	-11.3	-0.4	-38.0	0.81	9.9
Germany	-4.0	Q3	38.5	-5.4	-0.3	Dec	0.4	4.5	Oct	6.8	-7.0	-0.6	-27.0	0.81	9.9
Greece	-9.6	Q3	9.5	-9.0	-2.1	Nov	-1.4	16.1	Sep	-4.0	-8.2	0.6	-80.0	0.81	9.9
Italy	-5.0	Q3	80.4	-9.1	-0.2	Nov	-0.1	9.8	Oct	2.6	-11.0	0.5	-83.0	0.81	9.9
Netherlands	-2.5	Q3	34.8	-4.4	0.8	Nov	1.1	3.8	Mar	7.2	-6.9	-0.6	-42.0	0.81	9.9
Spain	-9.0	Q3	83.6	-11.4	-0.5	Dec	-0.2	16.2	Oct	0.6	-11.0	nil	-35.0	0.81	9.9
Czech Republic	-5.2	Q3	30.7	-6.6	2.7	Nov	3.2	2.9	Oct <sup>‡</sup>	1.2	-7.8	1.3	-26.0	21.3	5.9
Denmark	-3.8	Q3	22.6	-4.0	0.5	Nov	0.4	4.6	Oct	8.5	-4.8	-0.5	-18.0	6.06	10.2
Norway	-0.2	Q3	19.7	-1.7	0.7	Nov	1.4	5.2	Oct <sup>†††</sup>	3.2	-1.3	0.9	-52.0	8.44	4.3
Poland	-1.8	Q3	35.5	-3.4	3.0	Nov	3.4	6.1	Nov <sup>§</sup>	2.6	-7.9	1.3	-82.0	3.68	3.0
Russia	-3.4	Q3	na	-3.8	4.9	Dec	3.3	6.1	Nov <sup>§</sup>	1.9	-4.3	6.2	-19.0	73.9	-16.4
Sweden	-2.7	Q3	21.2	-3.2	0.2	Nov	0.4	7.7	Nov <sup>§</sup>	4.2	-3.6	nil	-12.0	8.21	14.6
Switzerland	-1.6	Q3	31.9	-3.0	-0.8	Dec	-0.9	3.4	Nov	9.2	-3.7	-0.5	-1.0	0.88	10.2
Turkey	6.7	Q3	na	-3.6	14.6	Dec	12.1	12.7	Sep <sup>§</sup>	-4.5	-5.1	12.7	68.0	7.29	-18.1
Australia	-3.8	Q3	14.0	-4.1	0.7	Q3	0.7	6.8	Nov	0.8	-7.9	1.0	-17.0	1.29	11.6
Hong Kong	-3.5	Q3	11.8	-5.6	-0.2	Nov	0.4	6.3	Nov <sup>††</sup>	5.6	-6.0	0.8	-91.0	7.75	0.3
India	-7.5	Q3	125	-7.9	6.9	Nov	6.7	9.1	Dec	1.3	-7.2	5.9	-68.0	73.1	-1.6
Indonesia	-3.5	Q3	na	-2.2	1.7	Dec	2.0	7.1	Q3 <sup>§</sup>	-1.4	-7.1	6.0	-106	13,895	0.3
Malaysia	-2.7	Q3	na	-5.3	-1.7	Nov	-1.1	4.7	Oct <sup>§</sup>	4.8	-7.2	2.6	-69.0	4.01	2.2
Pakistan	0.5	2020**	na	-2.8	8.0	Dec	9.6	5.8	2018	-0.2	-8.0	9.9	-117	160	-3.2
Philippines	-11.5	Q3	36.0	-9.3	3.5	Dec	2.6	8.7	Q4 <sup>§</sup>	0.5	-7.7	3.0	-152	48.0	6.0
Singapore	-3.8	Q4	8.7	-6.0	-0.1	Nov	-0.3	3.6	Q3	18.0	-13.9	0.9	-81.0	1.32	2.3
South Korea	-1.1	Q3	8.8	-1.1	0.5	Dec	0.5	3.4	Nov <sup>§</sup>	3.8	-5.7	1.7	19.0	1,086	8.0
Taiwan	3.9	Q3	16.6	2.4	0.1	Nov	-0.3	3.8	Nov	13.7	-1.5	0.3	-36.0	28.0	7.5
Thailand	-6.4	Q3	28.8	-6.1	-0.3	Dec	-0.8	2.0	Nov <sup>§</sup>	3.6	-6.3	1.2	-16.0	29.9	0.9
Argentina	-10.2	Q3	61.7	-10.7	35.8	Nov <sup>‡</sup>	42.2	11.7	Q3 <sup>§</sup>	2.0	-8.0	na	-464	84.9	-29.5
Brazil	-3.9	Q3	34.6	-4.5	4.3	Nov	3.2	14.3	Oct <sup>§††</sup>	-0.8	-15.8	2.3	-232	5.34	-24.2
Chile	-9.1	Q3	22.6	-6.2	2.7	Nov	3.0	10.8	Nov <sup>§††</sup>	2.1	-8.0	2.6	-55.0	698	10.5
Colombia	-9.5	Q3	39.6	-7.7	1.6	Dec	2.5	13.3	Nov <sup>§</sup>	-3.7	-8.8	4.8	-129	3,437	-5.5
Mexico	-8.6	Q3	58.0	-8.9	3.3	Nov	3.4	4.6	Nov	2.3	-4.5	5.2	-153	19.8	-4.8
Peru	-9.4	Q3	187	-12.0	2.0	Dec	1.8	14.2	Nov <sup>§</sup>	-0.1	-8.0	3.5	-64.0	3.63	-8.5
Egypt	0.7	Q3	na	3.6	5.7	Nov	5.1	7.3	Q3 <sup>§</sup>	-3.4	-7.9	na	nil	15.7	2.4
Israel	-1.5	Q3	38.9	-4.0	-0.6	Nov	-0.6	4.8	Nov	3.8	-11.1	0.8	4.0	3.19	8.8
Saudi Arabia	0.3	2019	na	-4.2	5.8	Nov	3.5	9.0	Q2	-3.7	-10.7	na	nil	3.75	nil
South Africa	-6.0	Q3	66.1	-7.2	3.2	Nov	3.2	30.8	Q3 <sup>§</sup>	-2.1	-16.0	8.7	45.0	15.1	-5.8

Source: Haver Analytics. \*% change on previous quarter, annual rate. †The Economist Intelligence Unit estimate/forecast. ‡Not seasonally adjusted. §New series. \*\*Year ending June. ††Latest 3 months. †††3-month moving average. §§5-year yield. ††††Dollar-denominated bonds.

## Markets

In local currency	Index Jan 6th	% change on:	
		one week	Dec 31st 2019
United States S&P 500	3,748.1	0.4	16.0
United States NAScomp	12,740.8	-1.0	42.0
China Shanghai Comp	3,550.9	4.0	16.4
China Shenzhen Comp	2,421.5	5.8	40.5
Japan Nikkei 225	27,055.9	-1.4	14.4
Japan Topix	1,796.2	-0.5	4.3
Britain FTSE 100	6,841.9	4.4	-9.3
Canada S&P TSX	17,828.1	1.6	4.5
Euro area EURO STOXX 50	3,611.1	1.1	-3.6
France CAC 40	5,630.6	0.6	-5.8
Germany DAX*	13,892.0	1.3	4.9
Italy FTSE/MIB	22,734.3	2.3	-3.3
Netherlands AEX	639.2	1.8	5.7
Spain IBEX 35	8,350.3	2.4	-12.6
Poland WIG	58,027.0	1.8	0.3
Russia RTS, \$ terms	1,436.7	3.5	-7.2
Switzerland SMI	10,747.1	0.4	1.2
Turkey BIST	1,505.4	1.7	31.6
Australia All Ord.	6,881.4	-0.9	1.2
Hong Kong Hang Seng	27,692.3	2.0	-1.8
India BSE	48,174.1	0.9	16.8
Indonesia IDX	6,065.7	1.4	-3.7
Malaysia KLSE	1,592.0	-3.2	0.2

	index Jan 6th	% change on:	
		one week	Dec 31st 2019
Pakistan KSE	45,153.4	3.3	10.8
Singapore STI	2,863.0	-0.2	-11.2
South Korea KOSPI	2,968.2	3.3	35.1
Taiwan TWI	14,983.1	2.0	24.9
Thailand SET	1,492.4	3.0	-5.5
Argentina MERV	51,880.0	1.3	24.5
Brazil BVSP	119,100.1	0.1	3.0
Mexico IPC	45,587.2	2.0	4.7
Egypt EGX 30	10,952.1	0.8	-21.6
Israel TA-125	1,570.9	0.2	-2.8
Saudi Arabia Tadawul	8,670.8	-1.0	3.4
South Africa JSE AS	61,857.4	3.7	8.4
World, dev'd MSCI	2,699.5	0.5	14.5
Emerging markets MSCI	1,315.3	2.0	18.0

## US corporate bonds, spread over Treasuries

	Dec 31st	
Basis points	latest	2019
Investment grade	137	141
High-yield	427	449

Sources: Refinitiv Datastream; Standard & Poor's Global Fixed Income Research. \*Total return index.

## Commodities

## The Economist commodity-price index

2015=100	% change on			
	Dec 29th	Jan 5th*	month	year
<b>Dollar Index</b>				
All Items	154.7	159.0	10.5	37.1
Food	119.5	123.4	11.8	22.0
<b>Industrials</b>				
All	187.5	192.1	9.8	48.1
Non-food agriculturals	129.2	131.3	10.5	27.5
Metals	204.8	210.2	9.6	52.7
<b>Sterling Index</b>				
All items	175.0	178.5	8.6	32.3
<b>Euro Index</b>				
All items	140.1	143.6	9.1	24.4
<b>Gold</b>				
\$ per oz	1,880.2	1,946.7	4.3	24.0
<b>Brent</b>				
\$ per barrel	51.2	53.7	9.5	-21.3

Sources: Bloomberg; CME Group; Cotlook; Refinitiv Datastream; Fastmarkets; FT; ICCO; ICO; ISO; Live Rice Index; LME; NZ Wool Services; Thompson Lloyd & Ewart; Urner Barry; WSJ. \*Provisional.

For more countries and additional data, visit [Economist.com/indicators](https://www.economist.com/indicators)

→ The languages of the rich world still dominate Wikipedia, both in articles and in editors

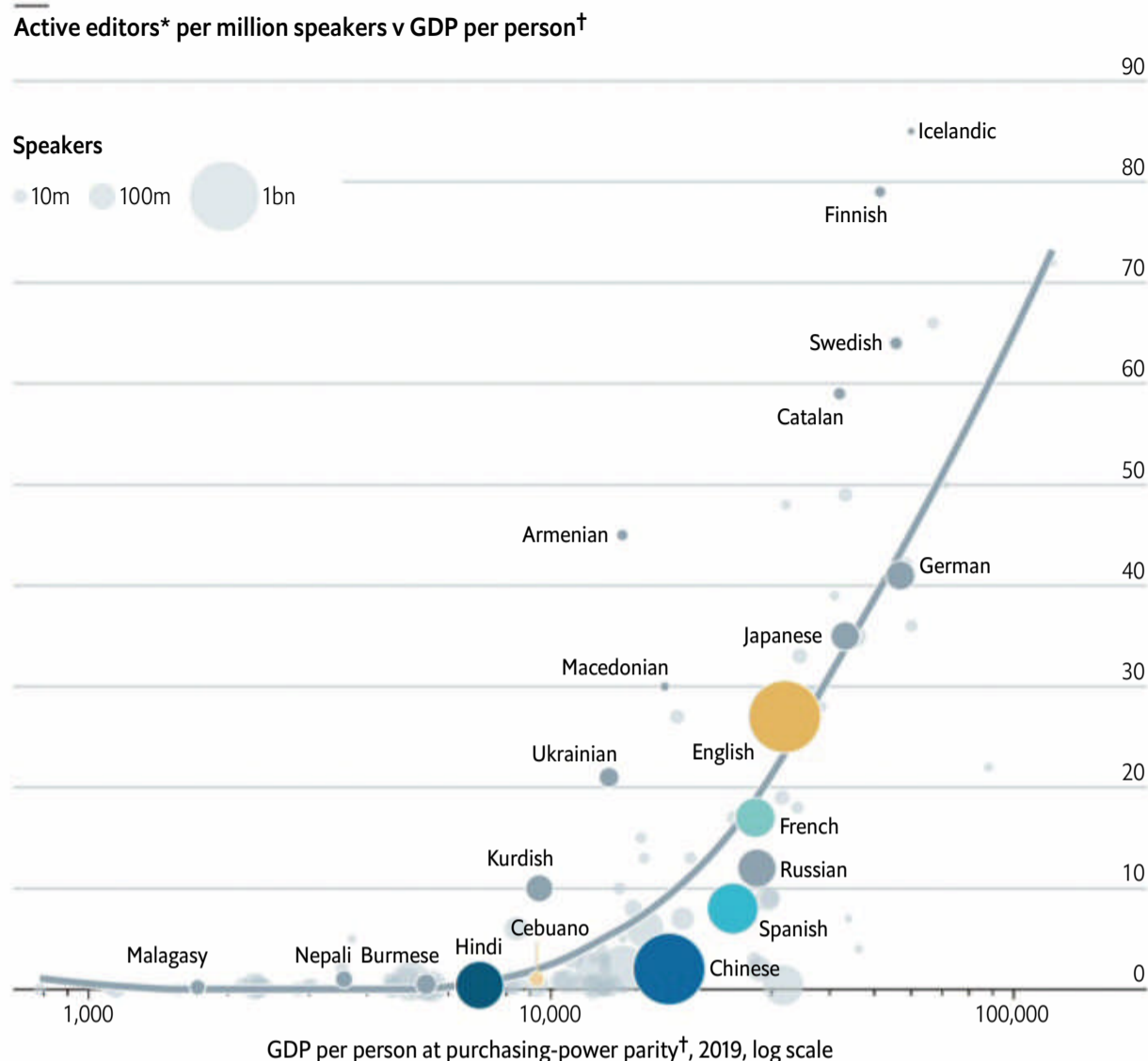

## A rich-world Wikippeak

### The online encyclopedia is still growing rapidly in Asia and Africa

THE MISSION statement “to organise the world’s information and make it universally accessible and useful” belongs to Google. However, the search engine’s ask-me-anything usefulness relies partly on the unpaid labour of the army of volunteer editors at Wikipedia, a collaborative online encyclopedia. Overseen by a not-for-profit group and dependent on constant donations of both money and time, Wikipedia is a brittle foundation for the world’s informational ecosystem (see International).

The number of people actively editing Wikipedia articles in English, its most-used language, peaked in 2007 at 53,000, before starting a decade-long decline. That trend spawned fears that the site would atrophy into irrelevance. Fortunately for Wikipedia’s millions of readers, the bleeding has stopped: since 2015 there have been around 32,000 active English-language editors. This stabilising trend is similar for

other languages of European origin.

Meanwhile, as more people in poorer countries gain internet access, Wikipedia is becoming a truly global resource. The encyclopedia’s sub-sites are organised by language, not by nationality. However, you can estimate the typical wealth of speakers of each language by averaging the GDP per head of the countries they live in, weighted by the number of speakers in each country. (For Portuguese, this would be 80% Brazil, 5% Portugal and 15% other countries; for Icelandic, it is almost entirely Iceland.)

Using this method, the richest Wikipedi-

dias—as measured by the share of speakers of each language who are active editors—tend to cluster in rich Western countries. For example, Wikipedia in Swedish, which is spoken by some 10m people, is managed by around 600 people a month. In contrast, Burmese, spoken by roughly 50m people, usually has fewer than a dozen people minding its site in a given month.

This leaves the Wikipedias of most of the languages of Asia and Africa either bereft of articles or at the mercy of automation. Such sites are prone to including articles written by bots. After English, the language with the most articles on Wikipedia is Cebuano, spoken by just 20m people in the Philippines. Nearly all were translated from English by a computer program created by a physicist in Sweden.

Users frustrated by clunky machine-written prose can soon expect a reprieve. From 2010 to 2018 the number of active editors working in languages spoken in the richer half of countries in the world fell by 5%, but the corresponding figure for those spoken in the poorer half more than doubled. Wikipedia may have done the bulk of its organisation of the world’s information long ago, but most of the work towards making it universally accessible and useful still lies ahead. ■

### Contributors editing at least five articles per month

12-month moving average, log scale

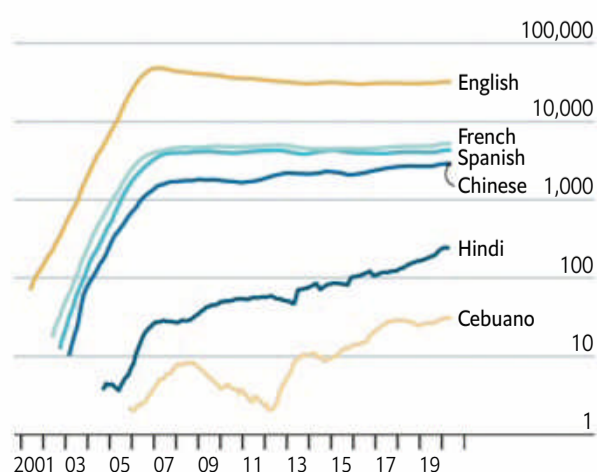

Sources: Wikimedia; World Bank; *The Economist* \*Editing at least five articles per month †Average of countries in which speakers of each language live, weighted by number of speakers in each country





## The milk of human kindness

**Agitu Ideo Gudeta, goat-herder, cheesemaker and symbol of integration, was killed on December 29th, aged 42**

**I**N ALL THE world there was nothing as beautiful as a goat. As she sat among them on the steep wooded slopes of the Valle di Felice, watching them tussle and shimmy in the tall weeds, Agitu Gudeta rejoiced in their long shoulders and strong legs, their compactness and the grace of their horns, curving back like swords. When they came close, for they loved crowding round, she fondled their ears and kissed their noses, stroked their fine hair and basked in the sight of their faces gazing down on her against the clear Italian sky.

These were not just any goats, but *Pezzata Mochena*, the ancient piebald race of the high Alpine region near the Austrian border. They came in all goat-colours, but mostly streaked and patched with black or warm red-brown. In 2010, when she bought 15, they were almost extinct; within a decade she had 180, and knew the names and characters of every one of them. So she would chide Cinnamon, as she gently cleaned her udder, for sitting in muck again, and rebuke Kay for trying to climb into her car, and as she led them all out to pasture she would shush them like a congregation of children, blithely twirling her stick in her slim black hands.

Yes, she was black. The goats did not notice, as they also paid no attention to her tall African hat. But people certainly did. The Mochena region was a closed place, still inhabited by descendants of Bavarians who ate dumplings, lived in chalets and spoke a dialect of German. They distrusted all strangers, including the regular pedlars who sold fabric out of their vans. And they had never seen a black face except on Shrove Tuesday, when carnival was led by the *betscho* and *betscha*, one in a skirt, one with a tall goatskin hat and a false hump made of straw, both in blackface, who clowned to bring prosperity. Now here among them was a real black woman, an Ethiopian refugee, living in the mountains alone with her goats.

Well, she thought as she worked away, herding and milking and scrubbing, she could bring in prosperity too. Her parents had gone to California; she had come here. She had fled from Ethiopia in

2010 with nothing, determined to leave nostalgia behind and reinvent herself. Her work back there, menaced by trigger-happy police and a warrant for her arrest, had been to defend nomadic herders whose grazing lands were being grabbed and leased to corporations by the government. Neo-colonialism, in a word. But in Italy too land was being squandered, good green land, as people left. So she did what her herding grandparents would have done: put her goats on communal pastures that had been abandoned, and let their munching and manuring gradually restore them.

The Mochena breed were not abundant milkers, but she soon had milk and yogurt to sell. Then came cheese, eventually 15 different kinds adapted to local tastes—of which her special treasures were the *primo sale*, the first fresh salted ones, which tasted completely different in a week. Her dairy in Frassilongo, the nearest village, was in a building once intended as a primary school when there were still enough children in the valley. There she stirred the big vats of curds just as joyfully as she led her goats up the valley, and taught local girls to make cheese as she had learned it on courses in France. Nothing pleased her more than hearing people say her cheese was good. It won prizes. In Trento, the main town of the region, she ran a stall on market day and in 2020 opened a shop called La Capra Felice, the Happy Goat, which served Ethiopian coffee alongside all the dairy stuff. Happiness was her watchword: happy goats, happy customers, a happy place filled with local activity. She called it her philosophy of community.

It was a crazy life, up at 6am to milk, then to the dairy or the shop, then up to the pasture, milking again, dairy again, paperwork, bed. It used all her strength, she adored it, and her sheer energy won the locals over. Journalists from around the world came to see her in her jeans, cami-top and Ethiopian hat, a symbol of integration for all of Italy. For the first eight years she could tell them, with her joyous smile, that there had never been any trouble. Suspicion, yes, at first. But actual trouble, no. And she had been lucky. After high school she had studied sociology in Rome and Trento on a scholarship, so she already spoke good Italian, and though she had returned to Ethiopia afterwards her Italian residency papers were still in order. In Trento, she still had friends. During last year's lockdown friends old and new passed word that she had a lot of perishable stock to clear, and everything was sold.

Yet there had always been more difficult neighbours: bears and wolves, which she scared away with bangers, and a few thugs, fans of hard-right politicians, who rode motorbikes among the goats or set their dogs on them. In 2018 a man came into the barn as she cleaned the milking machine, seized her by the shoulder and told her to go back home. Another sliced the udder from one of her loveliest pure-white goats. She had blamed wolves at first. It felt safer now to move down from her secluded mountain shelter to Plankerhof, a hamlet near Frassilongo, to a flat beside the church.

The intruders said her goats had damaged their property. They also objected to the African refugees and migrants she took on to help when she was busiest. That was her latest project, to use a fine resource that was being wasted, just like the land. She would find young men with permission to stay, but no work, and teach them to look after goats. Naturally they could handle it; they were refugees. Local jobless lads might want to join in too, and they could even form co-operatives—her teeming mind running ahead of itself, as usual. She began by taking on one young man at a time, from Ghana or Mali, hoping to transform them into goat-lovers as fervent as herself. From the start, as they climbed up to pasture, she would ask them: “Are you happy?” They had to be, she felt. But it was not so for Suleiman from Ghana, who just after Christmas argued with her about unpaid wages, and ended by killing her.

Evading the police, he fled up to the barn and tried to lose himself among the goats. But they were hungry and agitated by the absence of their mistress, and did not welcome him. Once he was taken away, the good neighbours of Frassilongo trudged through the snow to feed them. ■

The  
Economist

*Exclusive live digital event*

# Covid vaccines: your questions answered

Thursday January 14th  
4pm GMT / 11am EST / 8am PST

As covid-19 vaccines are rolled out across the world, *The Economist* will answer your questions on challenges that lie ahead. Our panel will explore the vaccine development process, the risks of misinformation in a pandemic and queries around supply and uptake.

Reserve your space:  
[economist.com/vaccines](https://economist.com/vaccines)



**Natasha Loder**  
Health-policy editor



**Edward Carr**  
Deputy editor



**Sacha Nauta**  
Public-policy editor



**John McDermott**  
Africa correspondent